

®

***Innovative Technology***

INTELLIGENCE IN VALIDATION

NV10  
Family

[GA02116]

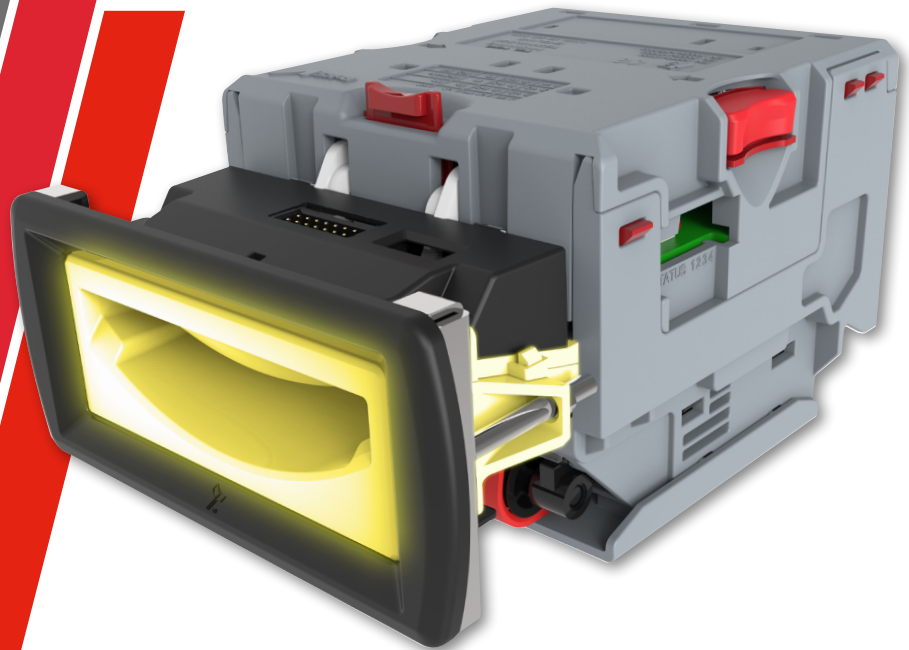

**USER MANUAL**

# NV10 FAMILY USER MANUAL

[<< Back to Contents](#)

Document Name:	NV10 Family User Manual
Document Version:	1.1
Date of Release:	19/04/2018

## TABLE OF CONTENTS

<b>1</b>	<b>DOCUMENT INTRODUCTION .....</b>	<b>4</b>
1.1	RELATED DOCUMENTS .....	4
1.2	MANUAL AMENDMENTS.....	4
1.3	COPYRIGHT .....	4
1.4	LIMITED WARRANTY .....	4
1.5	PRODUCT SAFETY INFORMATION .....	5
1.6	DISCLAIMER .....	5
<b>2</b>	<b>PRODUCT INTRODUCTION .....</b>	<b>7</b>
2.1	GENERAL DESCRIPTION.....	7
2.2	KEY FEATURES .....	7
2.3	TYPICAL APPLICATIONS .....	7
2.4	COMPONENT OVERVIEW .....	7
2.5	BEZEL OPTIONS.....	8
<b>3</b>	<b>TECHNICAL DATA .....</b>	<b>10</b>
3.1	DIMENSIONS .....	10
3.2	WEIGHT .....	10
3.3	ENVIRONMENTAL REQUIREMENTS .....	10
3.4	POWER REQUIREMENTS .....	11
3.4.1	Supply Voltages.....	11
3.4.2	Power Supply Guidance .....	11
3.5	MEDIA REQUIREMENTS .....	11
<b>4</b>	<b>MECHANICAL INSTALLATION .....</b>	<b>12</b>
4.1	COMPATIBILITY .....	12
4.1.1	Hardware Compatibility.....	12
4.1.1.1	Machine Mounting .....	12
4.1.1.2	Machine Interfacing.....	12
4.1.1.3	Power Supply .....	12
4.1.2	Software Compatibility .....	13
4.1.2.1	Interface Protocols.....	13
4.1.2.2	Re-programming .....	13
4.2	BEZEL REMOVAL .....	14
4.3	FREE FALL CASHBOX ADVICE.....	16
<b>5</b>	<b>SOFTWARE INSTALLATION AND CONFIGURATION.....</b>	<b>17</b>
5.1	INTRODUCTION .....	17
5.2	SOFTWARE DOWNLOADS .....	17
5.3	DRIVERS .....	17
5.4	DATASET/FIRMWARE PROGRAMMING .....	18
5.4.1	Validator Manager.....	18
5.4.1.1	General Description .....	18
5.4.1.2	System Requirements .....	18
5.4.1.3	Hardware Setup .....	18
5.4.1.4	Switching to Programming Mode (SSP) .....	18
5.4.1.5	Programming the device .....	18
5.4.2	DA3 .....	20
5.4.2.1	General Description .....	20



# NV10 FAMILY USER MANUAL

[<< Back to Contents](#)

5.4.2.2	System Requirements .....	20
5.4.2.3	Re-programming via DA3 .....	20
5.4.3	SMART Update .....	21
5.4.4	Configuration Card .....	22
5.4.4.1	Programming mode .....	22
5.4.4.2	Instructions for use .....	22
5.4.5	SSP configuration card options .....	23
5.4.6	ccTalk configuration card options .....	24
5.4.7	MDB Configuration card options .....	25
5.4.8	Parallel mode configuration card options .....	26
5.4.9	PULSE mode configuration card options .....	27
5.4.10	SIO mode configuration card options .....	28
5.5	Configuration Button .....	29
5.5.1	Configuration Button Functions: .....	30
<b>6</b>	<b>PROTOCOLS AND INTERFACING .....</b>	<b>32</b>
6.1	INTRODUCTION .....	32
6.2	SSP AND ESSP .....	32
6.2.1	General Description .....	32
6.2.2	Pin Assignments .....	33
6.2.3	Example Drawings .....	34
6.3	ccTALK® .....	35
6.3.1	General Description .....	35
6.3.2	Pin Assignments .....	35
6.3.3	ccTalk® DES Encryption .....	36
6.4	MDB .....	37
6.4.1	General Description .....	37
6.4.2	Pin Assignments .....	37
6.4.3	IF5 Interface .....	38
6.5	PARALLEL .....	39
6.5.1	General Description .....	39
6.5.2	Pinout .....	39
6.5.3	Inhibit Control .....	40
6.5.4	Busy Control .....	40
6.5.5	Low Power Mode .....	40
6.5.6	Escrow Control .....	40
6.5.7	IF10 Interface .....	40
6.6	BINARY .....	41
6.6.1	General Description .....	41
6.6.2	Pinout .....	42
6.6.3	Inhibit Control .....	42
6.6.4	Busy Control .....	42
6.6.5	Low Power Mode .....	43
6.6.6	Escrow Control .....	43
6.6.7	IF9 Interface .....	43
6.7	SIO AND SI2 .....	44
6.7.1	General Description .....	44
6.7.2	Pinout .....	47
6.8	PULSE .....	48
6.8.1	General Description .....	48
6.8.2	Pinout .....	48
6.8.3	Inhibit Control .....	49
6.8.4	Busy Control .....	49
6.8.5	Low Power Mode .....	49
6.8.6	Credit Hold Function .....	49
6.9	ESCROW CONTROL .....	49
6.10	IF15 INTERFACE .....	50



# NV10 FAMILY USER MANUAL

[<< Back to Contents](#)

<b>7</b>	<b>ROUTINE MAINTENANCE .....</b>	<b>51</b>
7.1	INTRODUCTION .....	51
7.2	RECOMMENDED CLEANING INTERVALS .....	51
7.3	RECOMMENDED BELT CHANGING INTERVALS.....	51
<b>8</b>	<b>FIRST LEVEL SUPPORT .....</b>	<b>52</b>
8.1	BEZEL/STATUS LED FLASH CODES .....	52
8.2	CHECKING POWER AND COMMUNICATION CONNECTIONS .....	53
8.3	PROGRAM CHECK PROCEDURE.....	53
<b>9</b>	<b>SECOND LEVEL SUPPORT .....</b>	<b>54</b>
9.1	INTRODUCTION .....	54
9.2	FAULT FINDING FLOW CHART .....	54
9.3	CLEANING THE NV10.....	56
9.3.1	<i>Belt cleaning</i> .....	58
9.4	CHANGING THE DRIVE BELTS .....	59
9.5	RE-INITIALISATION OF THE SENSORS .....	61
<b>10</b>	<b>COMPLIANCES AND APPROVALS .....</b>	<b>65</b>
10.1	EC DECLARATION OF CONFORMITY .....	65
<b>11</b>	<b>APPENDIX .....</b>	<b>67</b>
11.1	CABLE DRAWINGS .....	67
11.1.1	<i>CN214</i> .....	67
11.1.2	<i>CN174</i> .....	68
11.1.3	<i>CN392</i> .....	70
11.2	SWITCHING TO PROGRAMMING MODE (SSP) .....	71
11.3	DES TRUSTED (SAFE) MODE .....	72
11.3.1	<i>Introduction</i> .....	72
11.4	ESCROW CONTROL .....	74
11.5	ESCROW TIMING DIAGRAM .....	75
11.6	LOW POWER MODE TIMING DIAGRAM.....	77
11.7	ST PROCESSOR PCN .....	78
11.7.1	<i>NV10USB+</i> .....	78
11.8	FILE NAMING CONVENTION.....	80



## 1 DOCUMENT INTRODUCTION

### 1.1 Related Documents

This document should be read together with the following:

For SSP:

[Protocol Manual – SSP \(GA138\) SSP Interface Protocol Specification for integration](#)  
[SSP Implementation Guide \(GA973\) Information for programmers and integrators](#)

For Software:

[Software Manual – GA02037 Software Guide](#)

For other third party interface protocols please contact [support@innovative-technology.com](mailto:support@innovative-technology.com).

### 1.2 Manual Amendments

Rev.	Date	Amendment Details	Issued by
1.0	20/10/2017	First Issue	DG
1.1	19/04/2018	Second Issue	AVM

### 1.3 Copyright

This manual set is Copyright © Innovative Technology Ltd. 2016. No part of this publication may be reproduced in any form or by any means used to make any derivative such as translation, transformation, or adaptation without permission from Innovative Technology Ltd. The contents of this manual set may be subject to change without prior notice.

### 1.4 Limited Warranty

Innovative Technology Ltd warrants each of its hardware products to be free from defects in workmanship and materials under normal use and service for a period commencing on the date of purchase from Innovative Technology Ltd or its Authorized Reseller, and extending for the length of time stipulated by Innovative Technology Ltd.

A list of Innovative Technology Ltd offices can be found on the ITL website. If the product proves defective within the applicable warranty period, Innovative Technology Ltd will repair or replace the product. Innovative Technology Ltd shall have the sole discretion whether to repair or replace, and any replacement product supplied may be new or reconditioned.

The foregoing warranties and remedies are exclusive and are in lieu of all other warranties, expressed or implied, either in fact or by operation of law, statutory or otherwise, including warranties of merchantability and fitness for a particular purpose.

Innovative Technology Ltd shall not be liable under this warranty if it's testing and examination disclose that the alleged defect in the product does not exist or was caused by the customer's or any third person's misuse, neglect, improper installation or testing, unauthorized attempts to repair, or any other cause beyond the range of the intended use. In no event will Innovative Technology Ltd be liable for any damages, including loss of profits, cost of cover or other incidental, consequential or



[<< Back to Contents](#)

indirect damages arising out the installation, maintenance, use, performance, failure or interruption of an Innovative Technology Ltd product, however caused.

## 1.5 Product Safety Information

Throughout this user manual, we may draw your attention to key safety points that you should be aware of when using or maintaining the product.

These safety points will be highlighted in a box, like this:

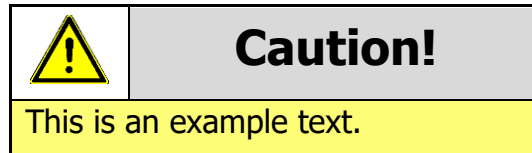

This user manual and the information it contains is only applicable to the model stated on the front cover, and must not be used with any other make or model.

## 1.6 Disclaimer

Innovative Technology Ltd is not responsible for any loss, harm, or damage caused by the installation and use of this product. This does not affect your local statutory rights. If in doubt please contact Innovative Technology for details of any changes.

Innovative Technology Ltd has a policy of continual product improvement. As a result the products supplied may vary from the specification described here.

Innovative Technology Ltd does not accept liability for any errors or omissions contained within this document. Innovative Technology Ltd shall not incur any penalties arising out of the adherence to, interpretation of, or reliance on, this standard.





## Safety Notice! Read before using this product!

**Safety Notice - Warning.** Ensure power is removed before allowing access to the inside of this product. Ensure any static build up is discharged before allowing access to any part of this product or media contained. Always earth this product/base plate in accordance with the manual.

For use only in or with complete equipment where the acceptability of the combination is determined by UL LLC. When installed in an end-product, consideration must be given to the following:

- The power supply terminals and/or connectors are: Not investigated for field wiring
- The investigated Pollution Degree is: 2
- The following end-product enclosures are required: Mechanical, Fire

**Sicherheitshinweis – Warnung:** Es muss sichergestellt werden, dass das Gerät von der Versorgungsspannung getrennt wird, bevor ein Eingriff in das Innere des Gerätes erfolgt. Es muss sichergestellt werden, dass jegliche statische Aufladung des Gerätes entladen wird, bevor auf das Gerät oder auf innerhalb des Gerätes befindliche Objekte zugegriffen wird. Die Erdung des Gerätes muss immer gemäß Handbuch erfolgen.

Nur für die Verwendung in oder mit kompletter Ausstattung, dessen Eignung und Kombination von der UL LLC ermittelt wurde. Bei der Installation in einem Endprodukt, muss folgendes berücksichtigt werden:

- Die Spannungsversorgungsklemmen und/oder Verbinder sind: Feldverkabelung wurde nicht untersucht
- Der untersuchte Verschmutzungsgrad ist: 2
- Folgende Anforderungen an die Gehäuse des Endproduktes sind gefordert: Mechanisch, Feuer

**Aviso de seguridad:** Asegúrese de que la alimentación está desconectada y de que toda la energía estática es descargada antes de manipular este producto. Conecte a tierra la chapa base de la manera que se indica en el manual.

Solo para uso con dispositivos con los cuales la compatibilidad ha sido certificada por UL LLC. Tras su instalación en producto acabado, tener en cuenta lo siguiente:

- Los conectores y terminales de alimentación son: No se ha investigado/especificado cableado externo.
- El grado de contaminación determinado es: 2
- Los siguientes manuales/certificados de producto final son requeridos: Mecánico, Fuego

**Avis de sécurité :** Assurez-vous que l'alimentation est coupée et que toute l'énergie statique est déchargé avant de manipuler ce produit. Connecter à la terre, la plaque de base à la manière indiquée dans le manuel.

A utiliser Seulement avec les dispositifs dont la compatibilité a été certifiée par UL LLC. Après son installation dans le produit fini, prendre en considération ce qui suit:-

- Les connecteurs et les bornes d'alimentation sont : cela n'a pas été étudié/spécifié câblage externe.
- Le degré de contamination déterminé est: 2
- Les manuels suivants / les certificats du produit final sont nécessaires : mécanique, incendie

**Bezpečnostní upozornění.** Před manipulací uvnitř tohoto produktu se ujistěte, že je produkt odpojen od zdroje elektrického napětí. Ujistěte se, že jakýkoliv elektrostatický náboj byl vybit před manipulací s jakoukoliv částí tohoto produktu nebo obsaženým médiem. Vždy uzemněte tento produkt/základovou desku v souladu s návodem.

Pouze pro použití v nebo s kompletním vybavením, kde je přijatelnost kombinace určena UL LLC. Při instalaci v konečném produktu je třeba zvážit následující:

- Napájecí svorky a/nebo konektory: Nejsou sledované pro externí kabeláž
- Sledovaný stupeň znečištění je: 2
- Následující krytí konečného produktu jsou požadované: Mechanické, Protipožární



## 2 PRODUCT INTRODUCTION

### 2.1 General Description

The NV10 USB/+ is a compact, stackerless banknote validator suitable for most applications. Accepting over 100 different world currencies the NV10 USB/+ is a truly global product. A field proven validator the unit supports industry standard protocols, is simple to integrate and maintain.

The NV10 USB/+ is ideal for amusement and vending applications and comes with two bezel width options depending on currency.

### 2.2 Key Features

- Compact stackerless design
- Proven field reliability
- Future proof
- One build standard for Global Applications

### 2.3 Typical Applications

- Amusement
- Vending

### 2.4 Component Overview

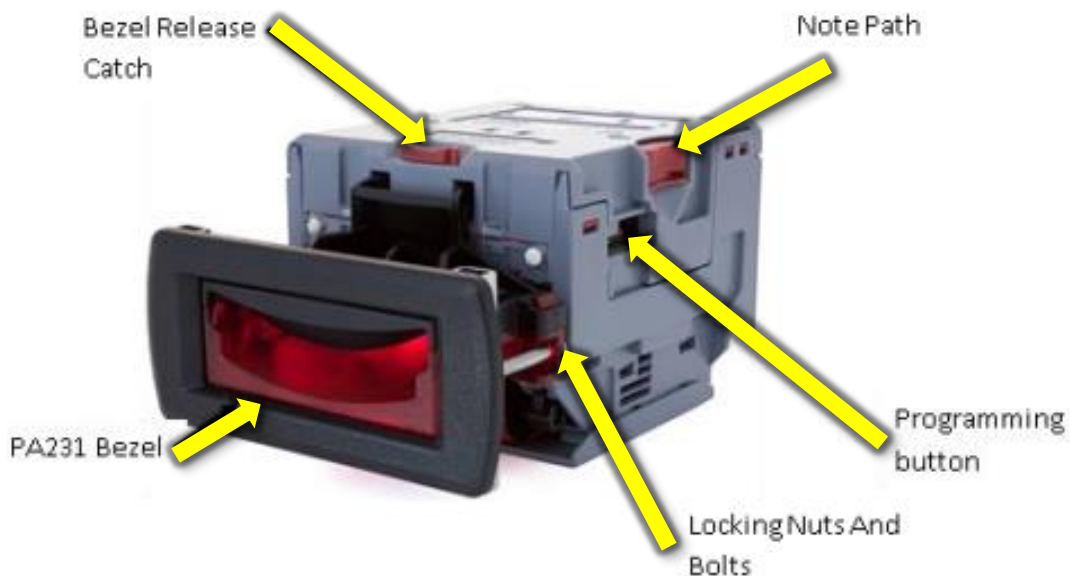



# NV10 FAMILY USER MANUAL

[<< Back to Contents](#)

## 2.5 Bezel Options

ITL Part Number	Description	Details	Pictures
PA00231	NV10 USB/+ Standard Bezel (82mm)	<a href="http://www.innovative-technology.com/de/shop/bezels/nv10-standard-bezel-detail">http://www.innovative-technology.com/de/shop/bezels/nv10-standard-bezel-detail</a>	
PA00266	NV10 USB/+ Extended Bezel	<a href="http://www.innovative-technology.com/de/shop/bezels/nv10-extended-bezel-detail">http://www.innovative-technology.com/de/shop/bezels/nv10-extended-bezel-detail</a>	
PA00267	NV10 USB/+ 66mm Width Extended Bezel	<a href="http://www.innovative-technology.com/shop/bezels/nv10-66mm-width-extended-bezel-detail">http://www.innovative-technology.com/shop/bezels/nv10-66mm-width-extended-bezel-detail</a>	



# NV10 FAMILY USER MANUAL

[<< Back to Contents](#)

PA01174	NV10 USB/+ Rainbow Bezel (82mm)	<a href="http://innovative-technology.com/it/shop-it/bezels/nv10-usb-rainbow-bezel-detail">http://innovative-technology.com/it/shop-it/bezels/nv10-usb-rainbow-bezel-detail</a>	
---------	---------------------------------------	---	--



## 3 TECHNICAL DATA

### 3.1 Dimensions

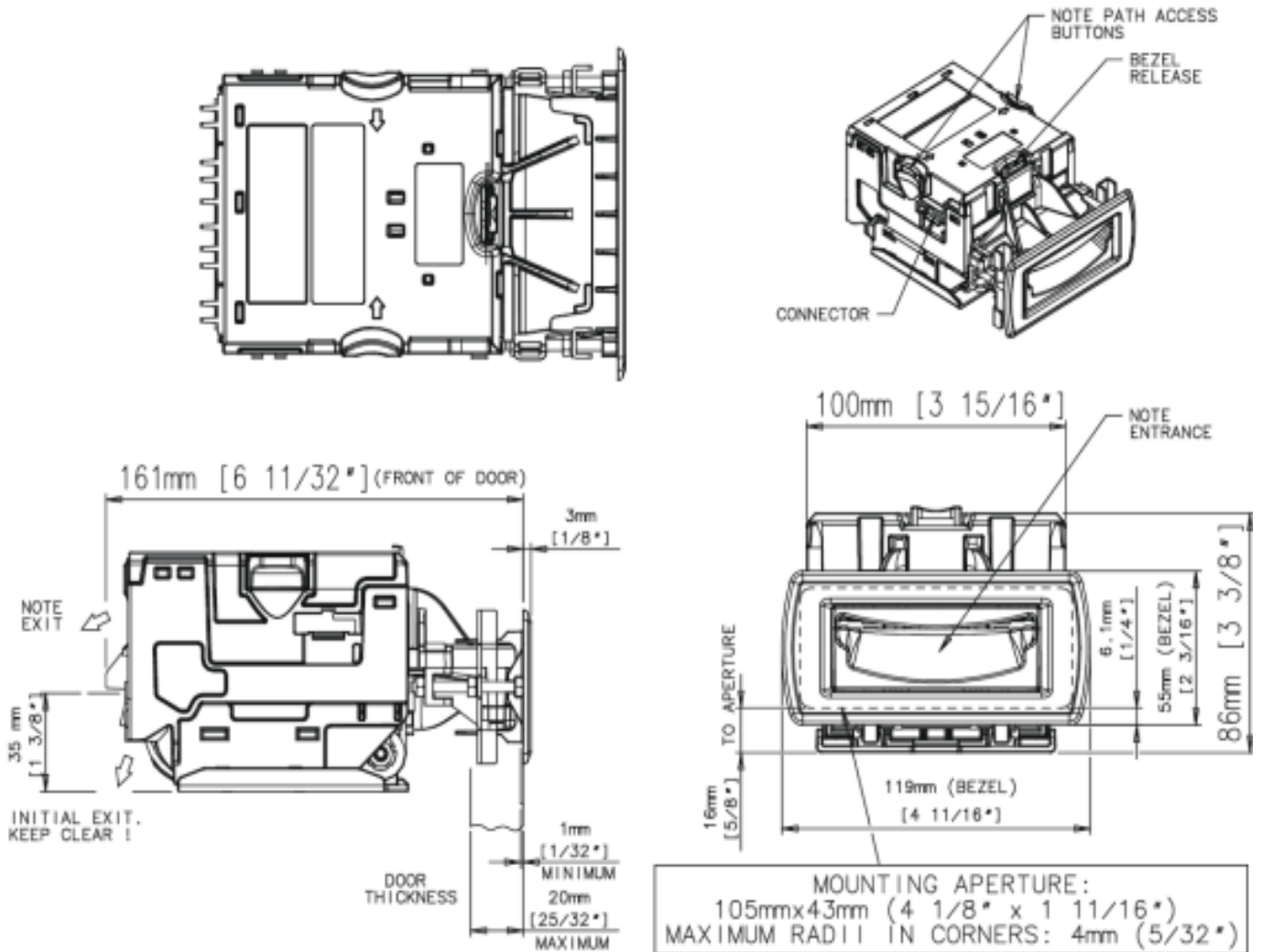

### 3.2 Weight

- Validator 0.55 kg

### 3.3 Environmental Requirements

Environment	Minimum	Maximum
Temperature	+3°C / 37°F	+50°C / 122°F
Humidity	5%	95% Non-condensing



## 3.4 Power Requirements

### 3.4.1 Supply Voltages

Supply Voltage	Minimum	Nominal	Maximum
Supply Voltage (V DC)	+10.8 VDC	+ 12 VDC	+13.2 VDC
Absolute limits (when fitted with IF5 interface)	+ 18 VDC	---	48 VDC or 34 VAC
Supply Ripple Voltage	0 V	0 V	0.25 V @ 100 Hz

### 3.4.2 Power Supply Guidance

The NV10 USB/+ requires a stable 12 V DC / 3 A power supply. Please check the power requirements of your host machine and other peripherals to dimension a suitable power environment for your machine setup.

TDK Lambda manufactures suitable power supplies. Please see table below for further details.

Power Supply Unit	Specification	RS Stock Code	Farnell Stock Code
TDK Lambda SWS50-12	+12 VDC / 4.3 A	466-5869	1184645

If the input voltage falls below 10.8 V the NV10 USB/+ may not operate correctly (will reject notes). The front bezel lights will flash to indicate incorrect conditions.

It is recommended that the power supply used can supply at least 1.5 amperes.

## 3.5 Media Requirements

The NV10 USB/+ is capable of handling multiple denominations simultaneously, the media that can be accepted includes but is not limited to:

- Polymer notes
- Windowed notes

The minimum and maximum dimension for media IN are as follows:

Note Sizes	Minimum	Maximum
Width	60 mm	85 mm
Length	115 mm	170 mm



## 4 MECHANICAL INSTALLATION

### 4.1 Compatibility

#### 4.1.1 Hardware Compatibility

##### 4.1.1.1 Machine Mounting

The NV10 USB/+ may not be used as fitting replacement for the following products:

- BV20
- BV100
- NV9
- NV150
- NV200

Innovative Technology Ltd. has a policy of continuous product improvement. Due to design changes older model or product bezels (and cashboxes) may not be compatible with the NV10 USB/+. However, new product deliveries always include a bezel (and cashbox if equipped) that must be used.

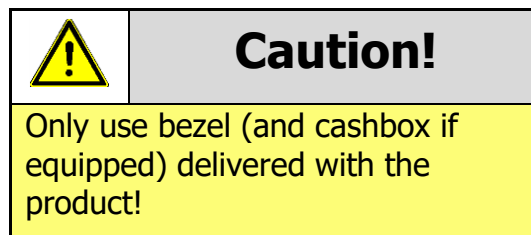

##### 4.1.1.2 Machine Interfacing

The NV10 USB/+ Validator is pin for pin compatible with the NV8 / NV9 / NV10 series validators, but NOT with earlier versions of the product (NV2 / NV5).

##### 4.1.1.3 Power Supply

It is vital that the NV10 USB/+ is connected to a power supply being able to provide the required power environment. A weak power supply causes malfunctioning of the NV10 USB/+ such like note rejects or missing credits. If the NV10 USB/+ is used as a fitting replacement for an older model or product we recommend to check the power supply specifications of the machine. The power supply of the machine might be designed for the older model or product but not suitable for the NV10 USB/+. The NV10 USB/+ might have higher power consumption. Refer to [3.4](#) for full power requirement details of the NV10 USB/+.

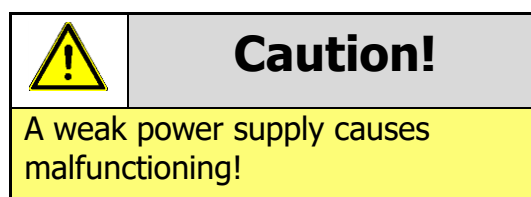

[<< Back to Contents](#)

## 4.1.2 Software Compatibility

### 4.1.2.1 Interface Protocols

When using the NV10 USB/+ as a fitting replacement for an older model or product some events such like credits may be given earlier. This is due to improved firmware routines and faster motors being used. This may cause missing events such like credits in those host machines where timeouts are defined for the older model or product. Please contact the machine manufacturer for full compatibility of the NV10USB/+.

	<b>Caution!</b>
Timing issues may cause missing events such like credits!	

### 4.1.2.2 Re-programming

For re-programming the NV10 USB/+ always use the latest version of Validator Manager available for download on our website. Older versions may not support the NV10 USB/+. For further details on Re-programming the NV10 USB/+ refer to [5.4.1.5](#)

	<b>Caution!</b>
Older versions of Validator Manager may not support the NV10!	



## 4.2 Bezel Removal



### WARNING!

Ensure bezel is secured to validator

The bezel should be secured to the validator head using screws if the NV10 USB/+ is being installed and transported inside a host machine.

1. Press the indicated button



- 
2. Pull the bezel downwards



[<< Back to Contents](#)

- 3.** Pull the bezel away from the NV10 USB/+ frame

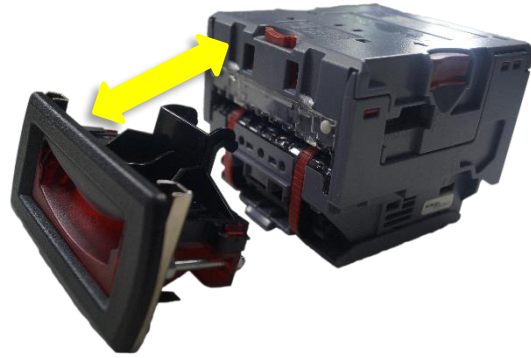



## 4.3 Free Fall Cashbox Advice

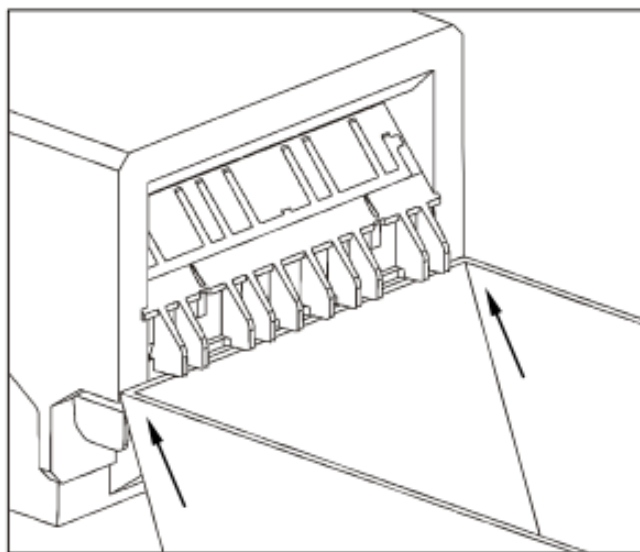
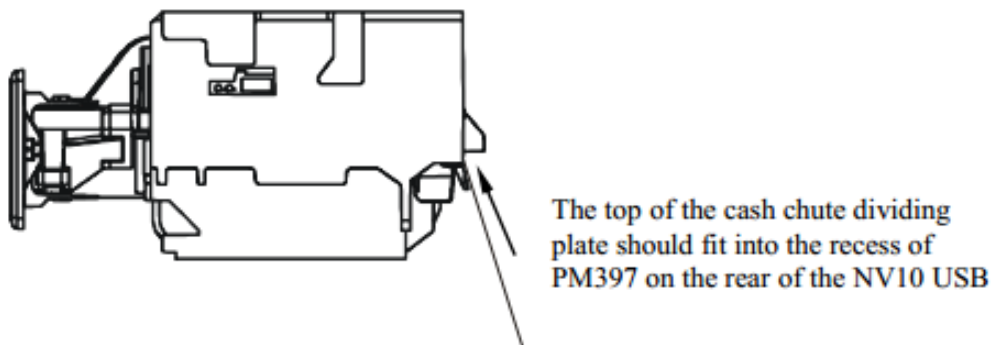
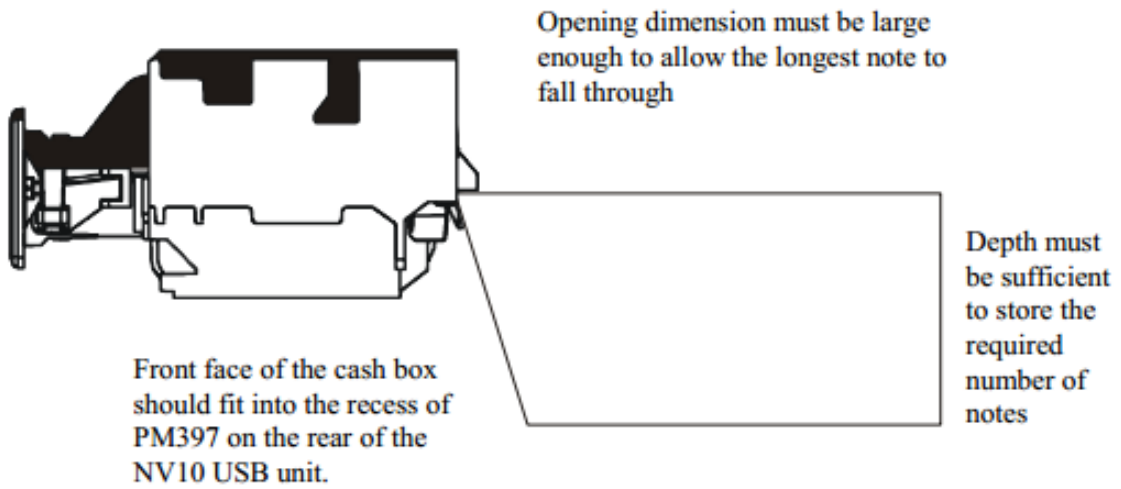

## 5 SOFTWARE INSTALLATION AND CONFIGURATION

### 5.1 Introduction

The NV10 USB/+ leaves the factory pre-programmed with the latest dataset and firmware files. However, it is important to ensure your device is kept up to date with the latest dataset and firmware. This section will give you a brief overview of the various update possibilities with the NV10 USB/+. For detailed instructions please refer to the relevant manual package supplied with the software or contact [support@innovative-technology.com](mailto:support@innovative-technology.com).

### 5.2 Software Downloads

All software from Innovative Technology Ltd is free of charge and can be downloaded from the website [www.innovative-technology.com/support/secure-download](http://www.innovative-technology.com/support/secure-download) once registered and logged in. If you are not registered, please create an account via the Create an account form. A confirmation email will be sent to the registered email address once all contact details have been successfully submitted.

As of June 2016 the ASIIC chip used in the NV10 was made obsolete by the manufacturer. As such a new board revision with a different processor was released. This resulted in a different hardware revision and firmware version, please see below:

The NV10 with ST chipset will have its own 'validator type' referenced in the dataset name (see below in RED):

Previous NV10 – EUR10**6**50

NV10 with ST chipset - EUR10**H**50

Ensure the correct version of firmware is being used for the product.

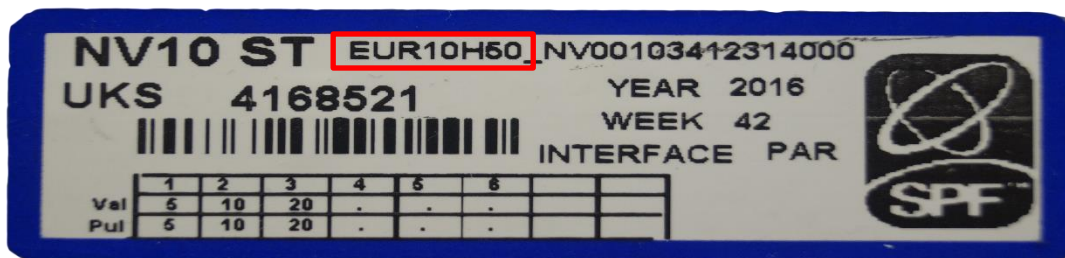

### 5.3 Drivers

The ITL drivers allow you to connect any of our validators to a compatible Windows device. If you are connecting via an IF17 then you will not need to follow this process as they are signed Microsoft Drivers and should install automatically. If this isn't the case or your computer is disconnected from the network, there is a standalone package included within the driver downloads.



[<< Back to Contents](#)

## 5.4 Dataset/Firmware Programming

### 5.4.1 Validator Manager

#### 5.4.1.1 General Description

Validator Manager is a utility which allows the user to reprogram any of ITL's validators, hoppers as well as coin and note recycler. Please note that admin rights are required during installation. The validator must be in SSP for the Validator Manager to detect the device.

#### 5.4.1.2 System Requirements

- Windows 7 or above
- .Net Framework 4
- 2015 C++ Redistributable
- 256mb ram
- 50mb hard disk free
- ITL Drivers
- Connected NV10 USB/+ with active com port

	<b>Caution!</b>
<p>We have seen instances where one of the dll's (itdata1.dll) used in Validator Manager are flagged as a Trojan, this is a false positive and if this happens you will need to add a rule to your antivirus to allow the file to run.</p>	

#### 5.4.1.3 Hardware Setup

Connect the power supply to the DA2/IF17. Connect the USB cable to the DA2/IF17 and to your computer or laptop. Connect the

Place setup drawing here, example below

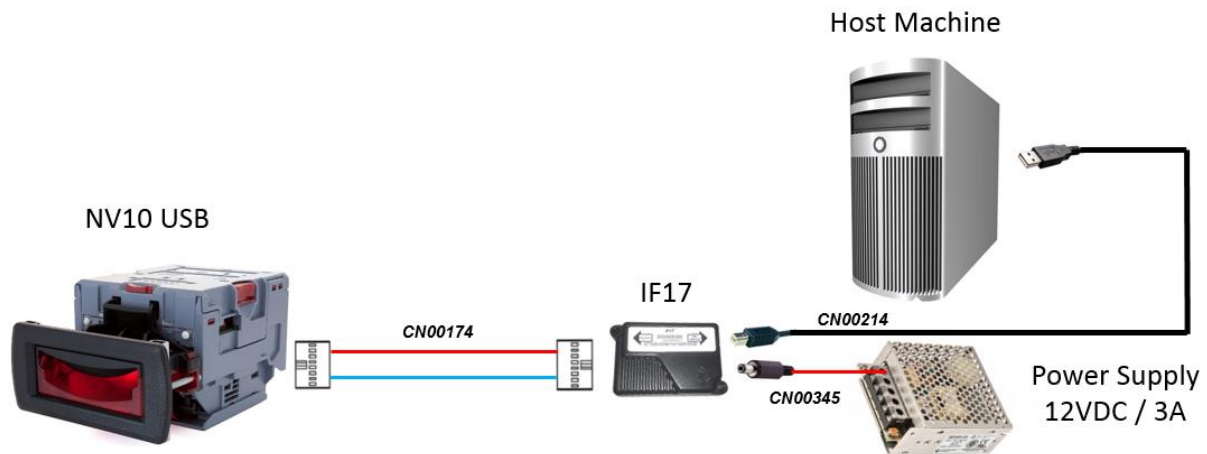

#### 5.4.1.4 Switching to Programming Mode (SSP)

Before programming via the Validator Manager the NV10 USB/+ needs to be switched to its programming mode (SSP interface). Please refer to [11.2](#) for the procedure for doing this.

#### 5.4.1.5 Programming the device

Once you have switched the unit into SSP, open Validator Manager and click detect devices. This will scan all active com ports for a unit, if your NV10 USB/+ fails to connect please ensure the correct drivers are installed and the unit is in SSP.



# NV10 FAMILY USER MANUAL

[<< Back to Contents](#)

By selecting the Program tab, you can reprogram the NV10 USB/+. To begin the upload, click open file, then browse to the file location (usually Downloads) before clicking OK.

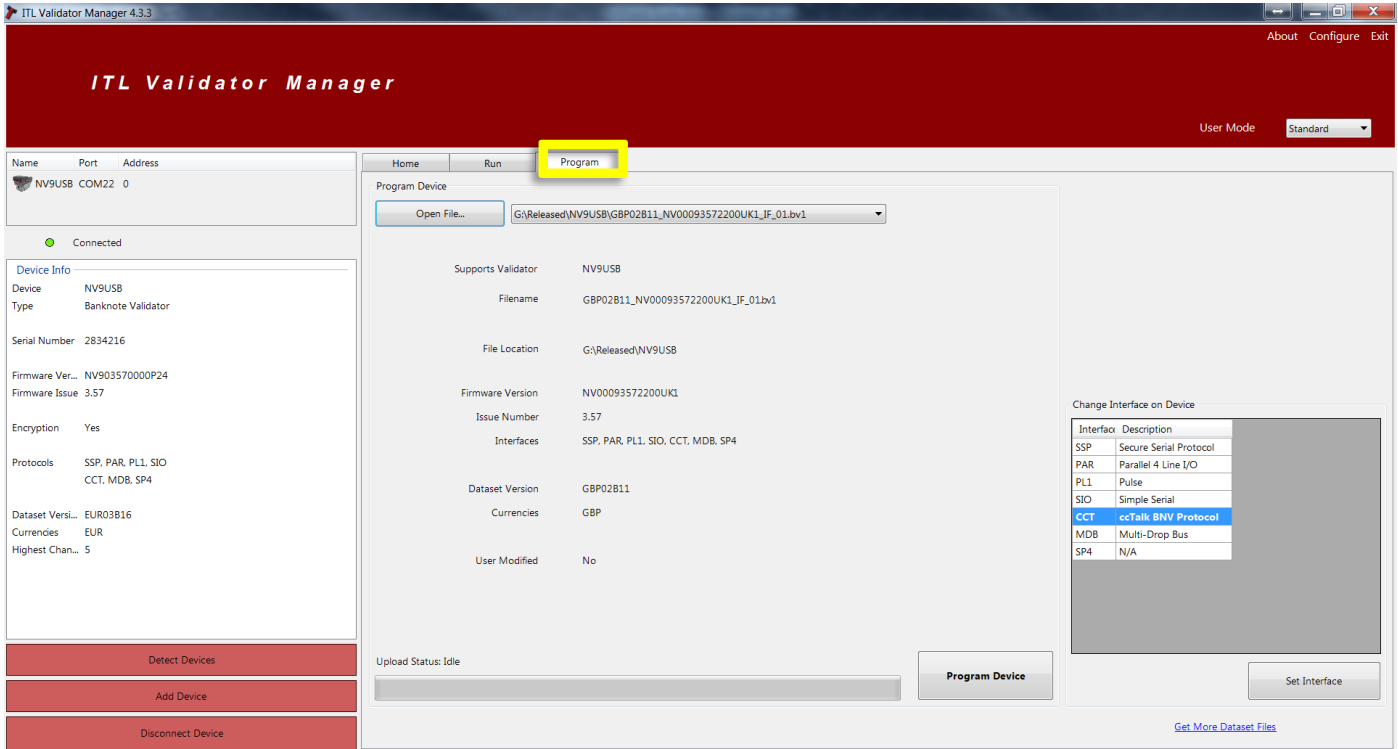

Once the file has been selected its information will be populated and the Program device tab will become active. Finally hit 'Program Device', the unit's bezel will now begin to flash signaling the update has begun.



**Caution!**

Interrupting the download process can result in the unit entering a non-functional state, once the process has started it cannot be halted.

When completed the unit will restart and a pop up box will appear saying Device Programming Complete.



## 5.4.2 DA3

### 5.4.2.1 General Description

The DA3 is a hand-held validator programming system that enables the user to re-program ITL banknote validators in the field, without the use of a PC. Dataset and firmware files for different validator models can be stored on the DA3. Once programmed the user can update or override existing software as well as test the functionality of the validator, away from the host machine.

### 5.4.2.2 System Requirements

- Windows XP SP3 or above
- .Net Framework 4
- 256mb ram
- 2015 C++ Redistributable
- 50mb hard disk free
- Connected DA3 with active com port
- Data Flash Card (PA01121) **optional**



### 5.4.2.3 Re-programming via DA3

To program the DA3 [Device Programming system](#) (DPS) needs to be used, this can be downloaded from our website. The DA3 connects to the PC through the USB port. Once the software is installed import the dataset into the DPS before uploading it to the DA3 internal memory.

Click to Update

Drag file across from the right hand side to the left then click Update Files.

Device	Country	Dataset	Firmware	Update mode	Available interfaces	I/F after update
NV200	POLAND	PLN01109	408	Match	SSP,CC1,MD6	N/A

Serial number	Value
Serial number	0
Firmware version	DA31001152167000
Loaded files	0

Device	Dataset	Firmware	Update mode	I/F after update

DA3 Firmware

Update Files

Card A

Card B

Copy DA3 to A

Copy A to DA3

Copy A to B

*This method is a match download so only a dataset with a matching denomination code will be programmed onto the validator. E.g. GBP06615 -> GBP06620.*



Once the files are loaded onto the DA3 the Validator can be updated. For this a ribbon cable needs to be connected between the validator port on the DA3 and the validator. The host machine cable connected to the spare port on the DA3 as shown

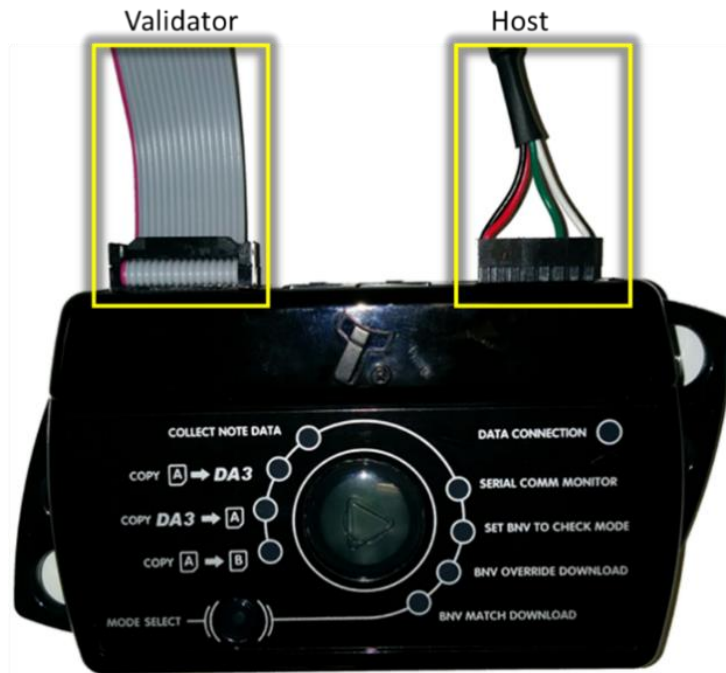

below:

Once the unit is connected, ensure it is in SSP, press the play button in the middle, the DA3 will begin to download. If there is an issue the 'BNV Match Download' LED will begin to flash.

Should an error occur whilst updating the unit via the DA3, a flash code will be displayed on the DA3 Mode LED indicator as shown below:

1 Long flash followed by –

Number of SHORT flashes	Indicated Status / Error
2	No validator connection found
3	No valid download files found
4	Download fail
5	Memory card fail

### 5.4.3 SMART Update

Smart update is a utility which bundles up a regions dataset into one file. No settings will be altered during the update only the dataset and firmware.

All the details of DA3 using can be found in the [DA3 User Manual](#)



## 5.4.4 Configuration Card

### 5.4.4.1 Programming mode

Press the configuration button once while the NV10 USB/+ is powered up. If done correctly, the Bezel LED will flash every second. This indicates that the validator is ready for the insertion of a Configuration Card to change the Firmware Protocol in the NV10 USB/+.

This mode can be cancelled by pressing the configuration button once.

Please consult ITL technical document GA959 for further information on configuration card programming – the GA959 document includes a printable template for the configuration card and this can be downloaded from the Support section of the ITL website – **the sample shown here should NOT be used for programming as it is not to scale.**

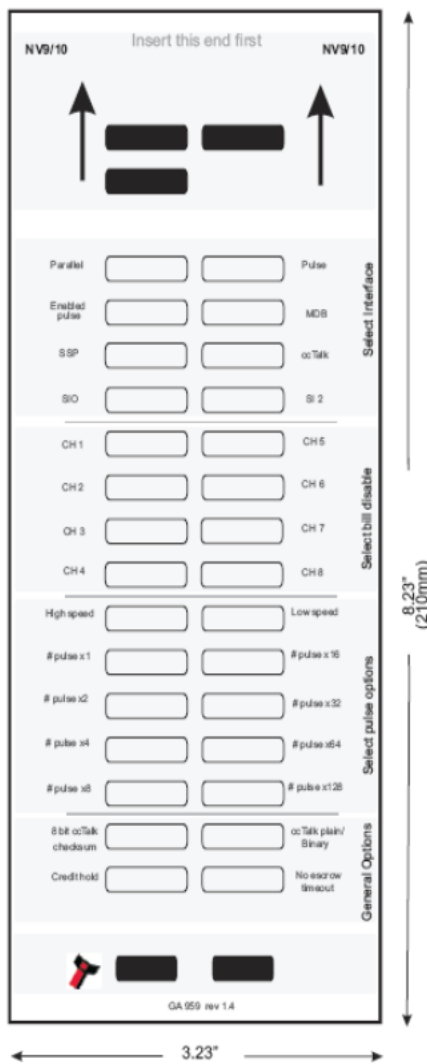

### 5.4.4.2 Instructions for use

1. Cut card around the outline – check the measurements are as printed. Make sure that 'Page scaling' is set to 'None' in your print options to ensure the correct size.
2. Fill in sections as required. Take care to fill in the sections correctly, keep inside the lines and fill boxes fully as shown here:



3. Power-up the validator and wait until it resets.
4. Press the configuration button once to enter programming mode (the bezel LEDs should flash at one second intervals).
5. Insert the card into the validator face up and in the direction indicated by the arrows.
6. The configuration card will be ejected and if the configuration was good the bezel LEDs will flash at a fast rate while programming takes place. After completion of programming, the validator will reset.





# NV10 FAMILY USER MANUAL

[<< Back to Contents](#)

## 5.4.5 SSP configuration card options

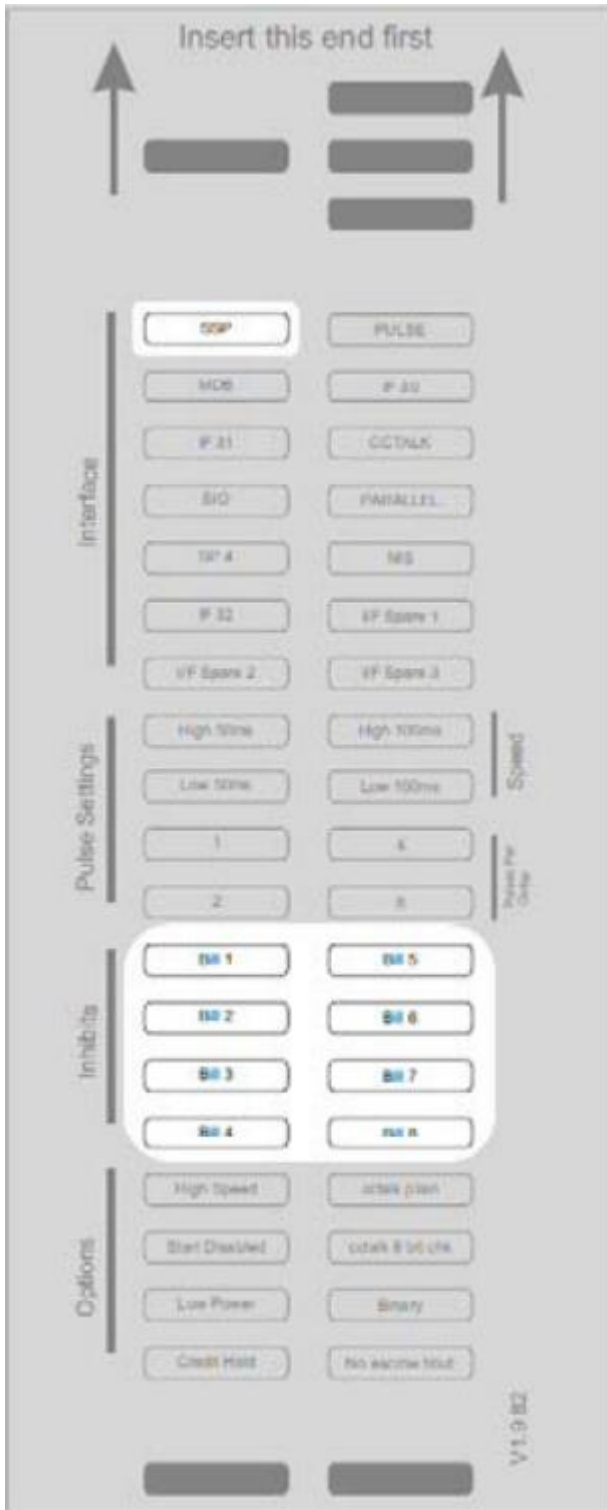

When using the configuration card to set SSP mode, the following options are available:

Note inhibits – fill in the boxes to inhibit notes





## 5.4.6 ccTalk configuration card options

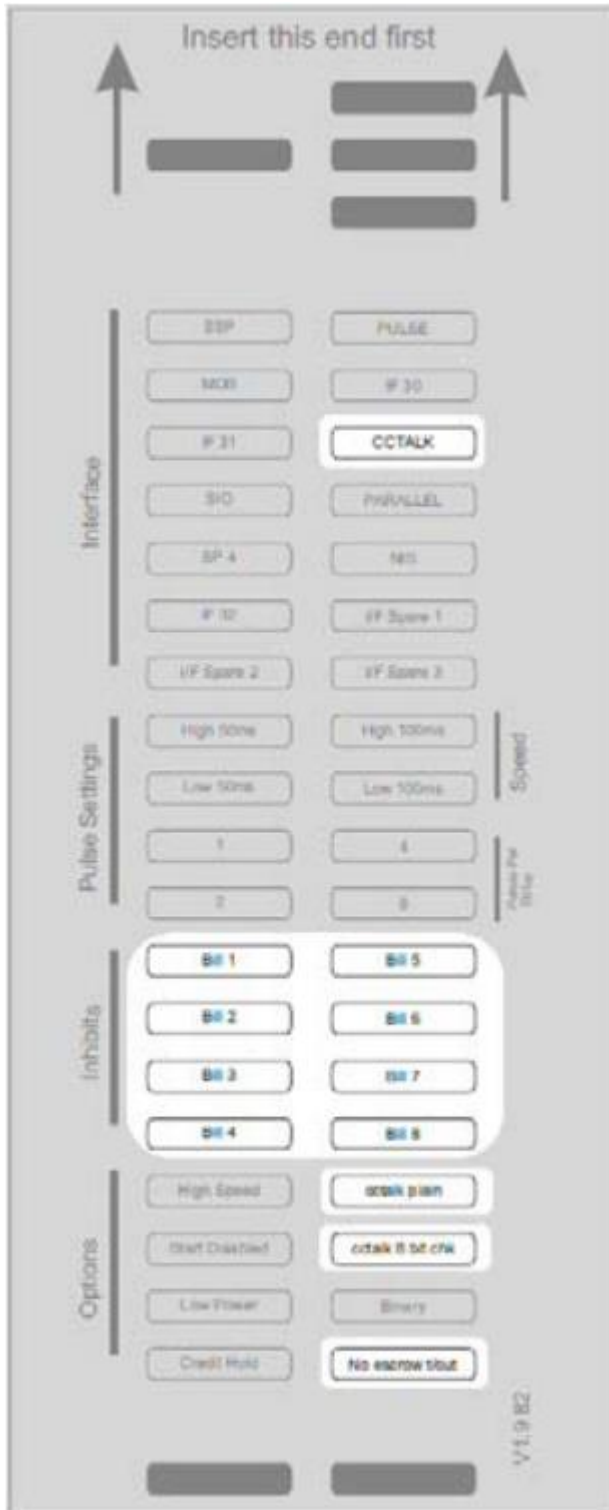

When using the configuration card to set ccTalk mode, the following options are available:

Note Inhibits – fill in the boxes to inhibit notes

ccTalk plain – fill in this box to use un-encrypted ccTalk

ccTalk 8 bit checksum – if 'ccTalk Plain' is selected, leave this box blank for 16 bit CRC checksum. Fill in this box to use simple 8 bit checksum se

No escrow t/out – fill in this box to disable the escrow timeout

# NV10 FAMILY USER MANUAL

[<< Back to Contents](#)

## 5.4.7 MDB Configuration card options

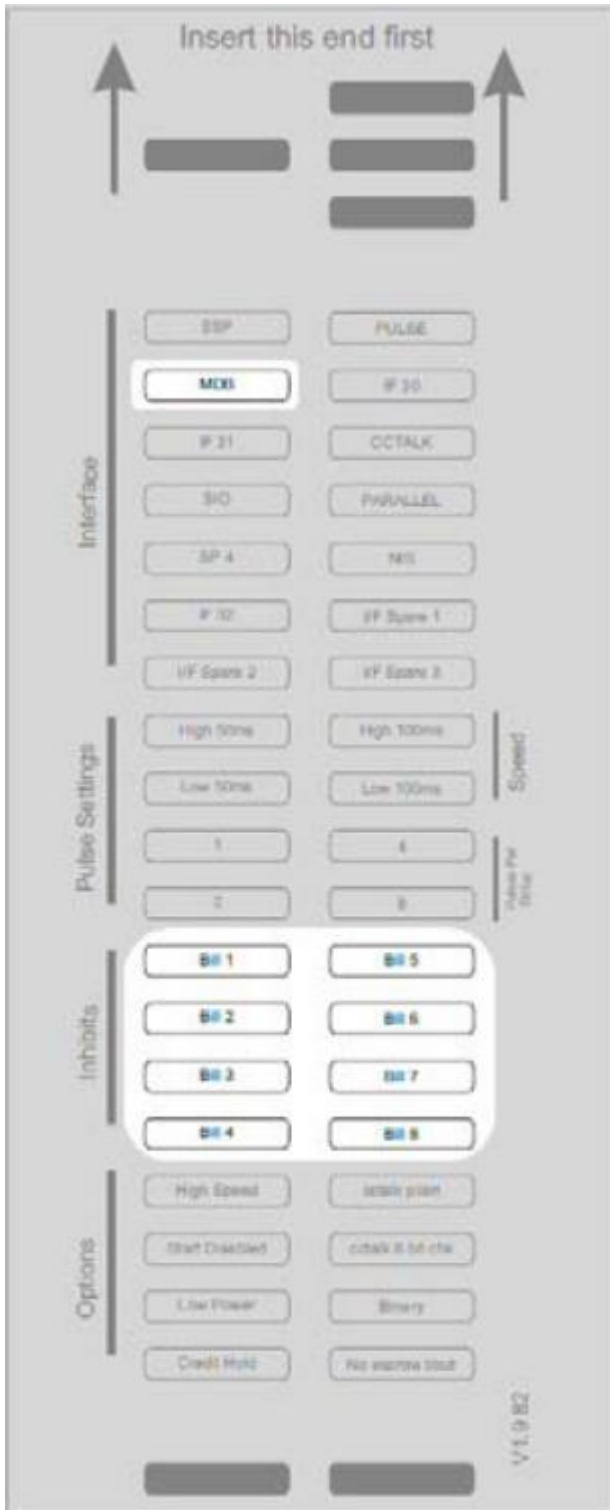

When using the configuration card to set MDB mode, the following options are available:

Note inhibits – fill in the boxes to inhibit notes



## 5.4.8 Parallel mode configuration card options

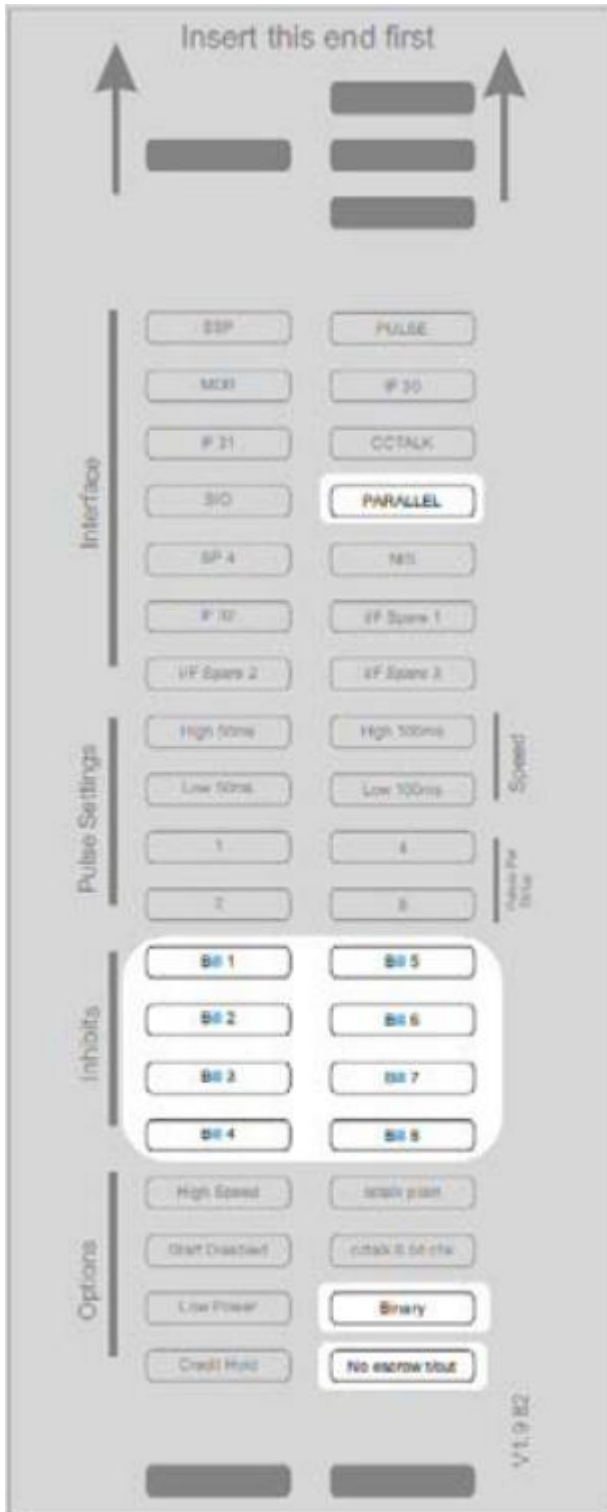

When using the configuration card to set parallel mode, the following options are available:

Note inhibits – fill in the boxes to inhibit notes

Binary – fill in this box to enable binary output mode

No escrow t/out – fill in this box to disable the escrow timeout

## 5.4.9 PULSE mode configuration card options

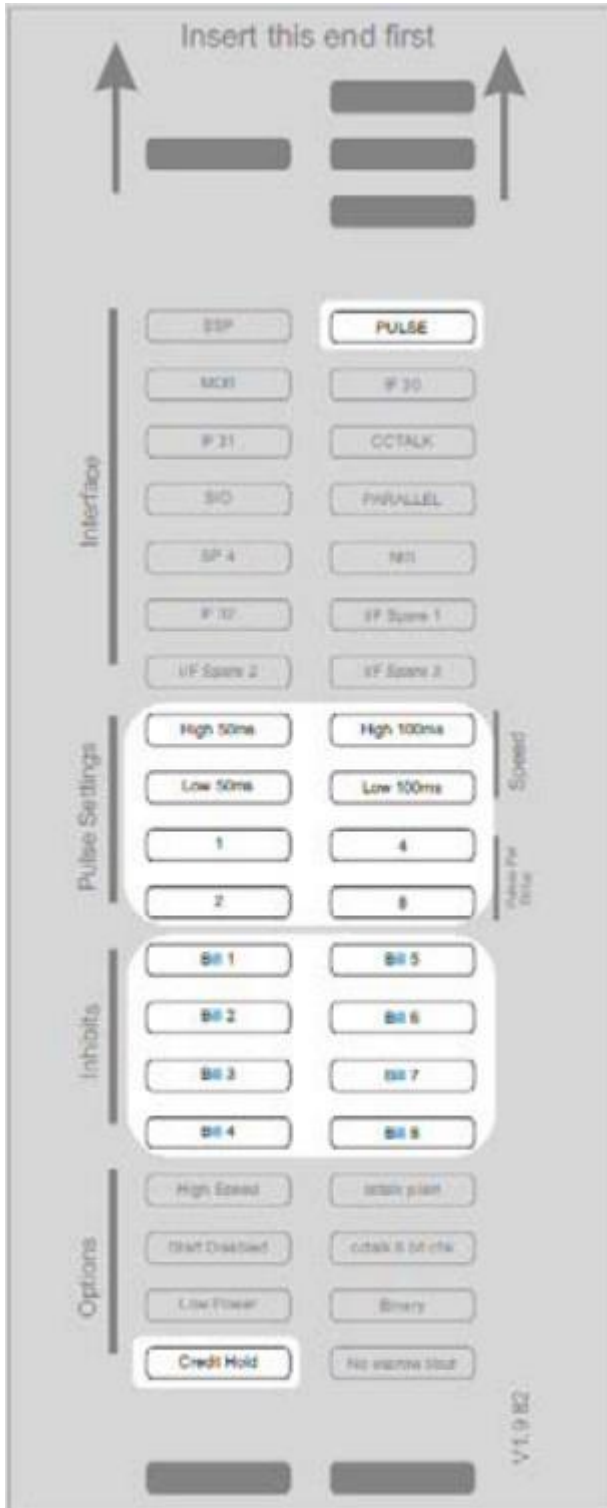

When using the configuration card to set pulse mode, the following options are available:

**Pulse Settings** – Select the required pulse widths and the pulse multiplier

**Note inhibits** – fill in the boxes to inhibit notes

**Credit Hold** – fill in this box to enable the credit hold function **NOTE:** The SP4 option is identical to Pulse mode but the NV10 USB/+ will always be enabled. It is not necessary to set the inhibits to enable the NV10 USB/+.



## 5.4.10 SIO mode configuration card options

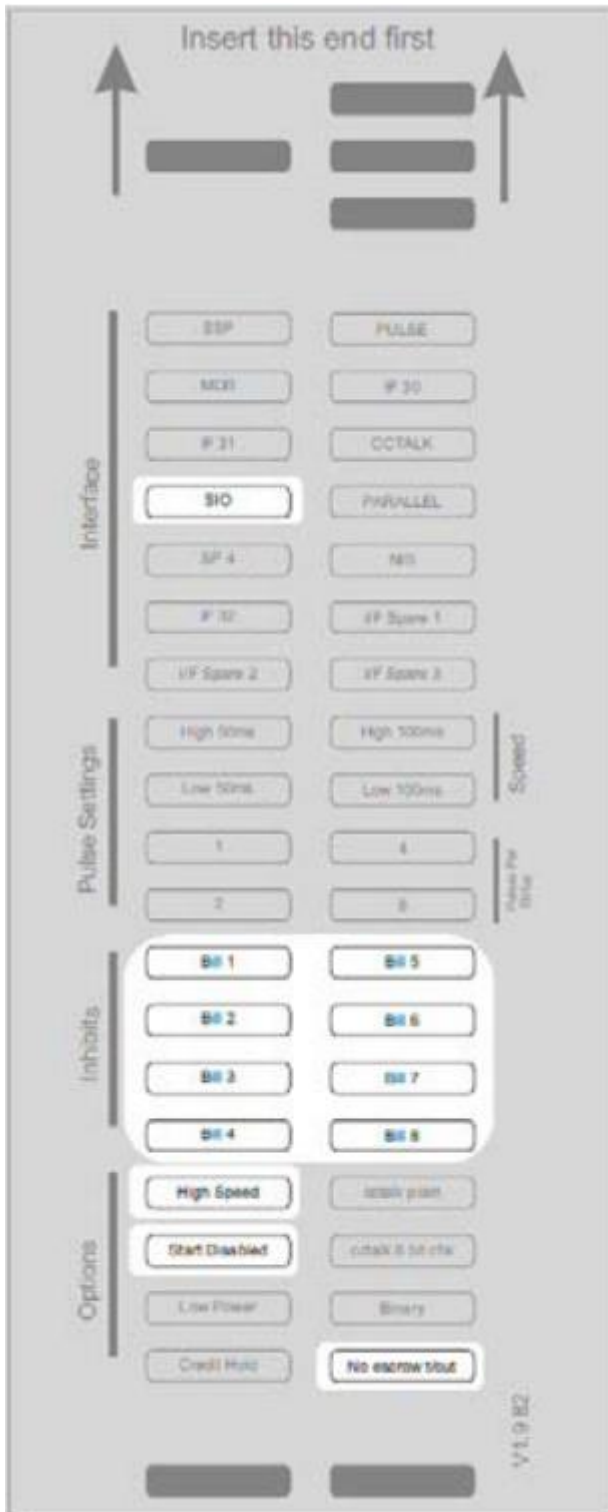

When using the configuration card to set SIO mode, the following options are available:

Note inhibits – fill in the boxes to inhibit notes

High Speed – fill in this box to use 9600 baud

Start Disabled – When this box is filled in, the NV10 USB/+ will start up in the disabled state

No escrow t/out – fill in this box to disable the escrow timeout

## 5.5 Configuration Button

The NV10 USB/+ does not use DIP switches to configure the unit – configuration and setting is carried out with the use of the Configuration Button mounted on the right hand side of the unit as indicated below:

When in programming mode, do not turn off the power before the operation is



**Configuration Button**

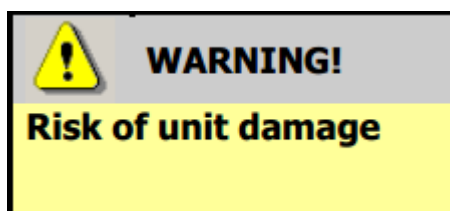

complete as this will make the unit unusable.

## 5.5.1 Configuration Button Functions:

Action	Power Status	Function	Confirmation
Press and hold (more than 2 seconds) until the bezel illuminates, then release	Powered ON	Sets validator to Programming mode (SSP)	Bezel will flash quickly and validator will restart
Press once (less than 1 second)	Powered ON	Enables Configuration Card programming – press again to cancel this mode	Bezel will flash on and off slowly while in this mode
Press twice (within half a second)	Powered ON	Shows current interface type	Bezel will flash – see the flash count table below



# NV10 FAMILY USER MANUAL

[<< Back to Contents](#)





## 6 PROTOCOLS AND INTERFACING

### 6.1 Introduction

The NV10 USB/+ supports standard industry protocols. Interfaces that are not listed may be available upon request. For any queries regarding interfaces that are not listed please contact [support@innovative-technology.com](mailto:support@innovative-technology.com).

	<b>Caution!</b>
The use of an encrypted protocol (preferable eSSP) is strongly recommended to achieve the highest security!	

### 6.2 SSP and eSSP

#### 6.2.1 General Description

Smiley® Secure Protocol (SSP) and Encrypted Smiley® Secure Protocol (eSSP) are field proven secure interfaces specifically designed by Innovative Technology Ltd. to address the problems by cash handling systems in gaming machines. Problems such as acceptor swapping, re-programming acceptors and line tapping are all addressed. This interface is recommended for all new designs. Innovative Technology Ltd. provides full SDK packages upon request including Interface Specification, Implementation Guide as well as source code examples for C++, C#.NET and Linux. Please contact [support@innovative-technology.com](mailto:support@innovative-technology.com) for further information.

The recommended communication protocol for the NV10 USB/+ validator is eSSP, as this provides the highest level of data transfer security. A ccTalk interface protocol is also available.

For detailed information and the full protocol specifications please read the following documents, which can be downloaded from the Innovative Technology Ltd website ([www.innovative-technology.com](http://www.innovative-technology.com)):

- SSP Interface Specification ([ITL Document number GA138](#))
- ITL Bank Note Reader ccTalk Specification ([ITL Document number GA966](#))

When communicating with the NV10 USB/+ validator, poll commands should be sent **at least** 200 ms apart.

	<b>Information</b>
200 ms command spacing	



# NV10 FAMILY USER MANUAL

[<< Back to Contents](#)

## 6.2.2 Pin Assignments

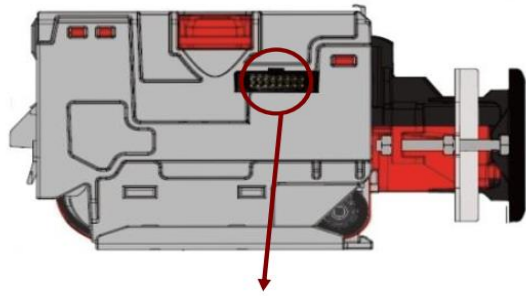

Interface Socket

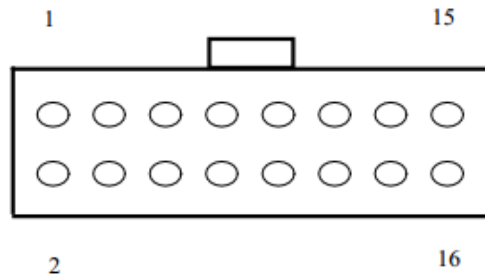
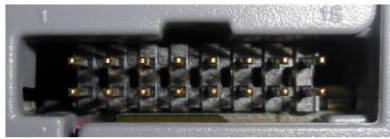

Pin	Name	Type	Description
1	Vend 1	Output	Serial Data Out (Tx)
2	Vend 2	Output	DA3 Data Logging
3	Vend 3	Output	Not Used
4	Vend 4	Output	Not Used
5	Inhibit 1	Input	Serial Data In (Rx)
6	Inhibit 2	Input	Not Used
7	Inhibit 3	Input	Not Used
8	Inhibit 4	Input	Not Used
9	Busy	Output	Not Used
10	Escrow	Input	Not Used
11	USB +	Data	USB Data +
12	USB -	Data	USB Data -
13	USB Vcc	Power	USB Vcc (+5VDC)
14	Factory Use Only		Do not connect
15	+ Vin	Power	+12VDC Supply
16	0V	Power	0V Supply (GND)

	<b>Caution!</b>
+12VDC and 0V (GND) must always be connected, also when using USB connections.	



# NV10 FAMILY USER MANUAL

[<< Back to Contents](#)

## 6.2.3 Example Drawings

The drawings below highlights how to connect the NV10 USB/+ to an SSP or eSSP host machine using available cables and interfaces from Innovative Technology Ltd. For cable drawings please refer to [11.1](#).

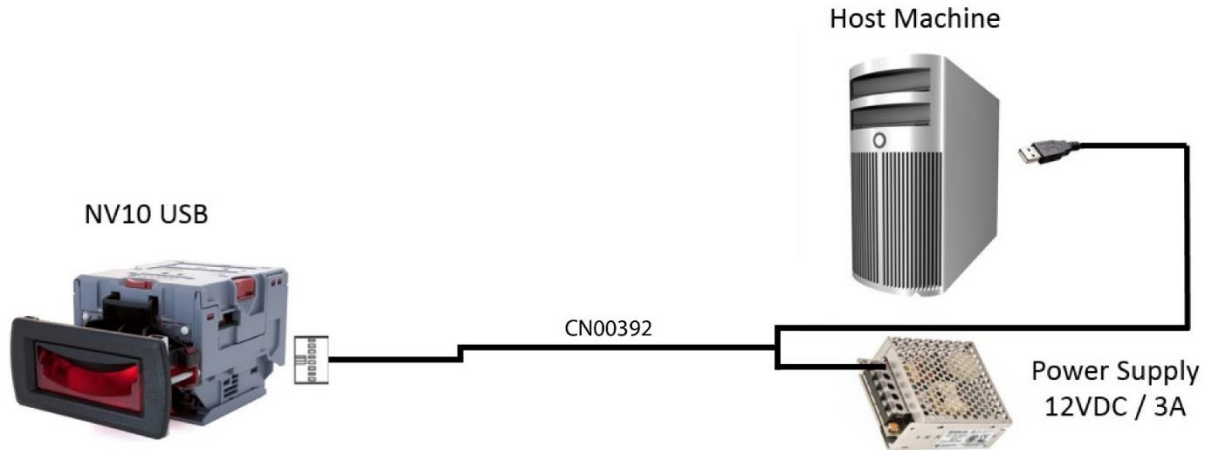

Type	ITL Part Number	Description	Details
Cable	CN00392	Validator to USB Cable	<a href="http://www.innovative-technology.com/de/shop/cables/nv9-nv10-usb-host-cable-detail">http://www.innovative-technology.com/de/shop/cables/nv9-nv10-usb-host-cable-detail</a>

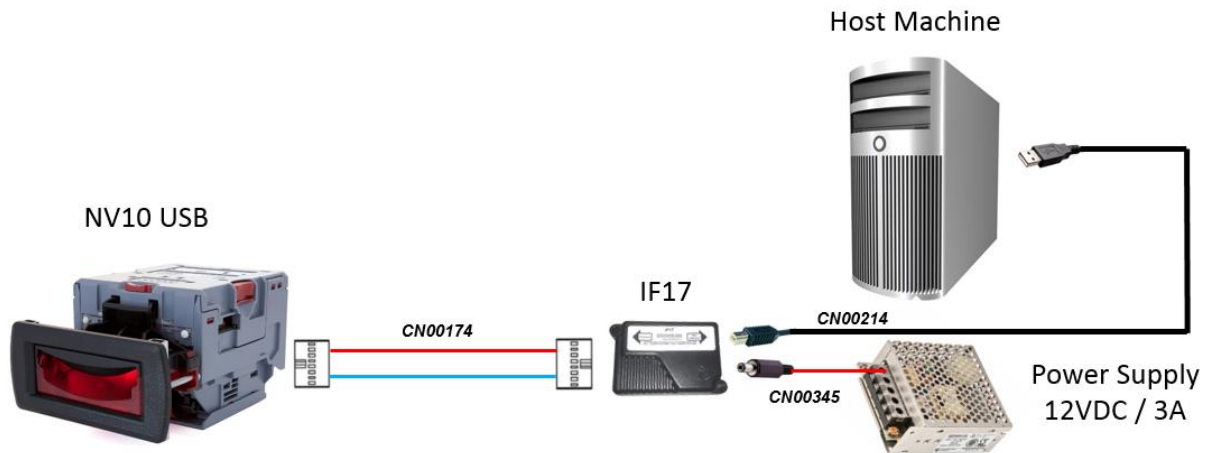

Type	ITL Part Number	Description	Details
Cable	CN00174	NV9 / NV10 Ribbon Cable	<a href="http://innovative-technology.com/shop/cables/nv9-nv10-ribbon-cable-detail">http://innovative-technology.com/shop/cables/nv9-nv10-ribbon-cable-detail</a>
Cable	CN00214	USB A to B cable assembly	<a href="http://innovative-technology.com/shop/cables/usb-a-to-b-cable-assembly-detail">http://innovative-technology.com/shop/cables/usb-a-to-b-cable-assembly-detail</a>
Cable	CN00345	DA3 / IF17 / IF18 Power Cable	<a href="http://innovative-technology.com/shop/cables/da3-if17-if18-power-cable-detail">http://innovative-technology.com/shop/cables/da3-if17-if18-power-cable-detail</a>
Interface	IF17	TTL to USB Converter	<a href="http://www.innovative-technology.com/shop/accessories/if17-interface-converter-detail">http://www.innovative-technology.com/shop/accessories/if17-interface-converter-detail</a>



	<b>Caution!</b>
Innovative Technology Ltd. provides full SDK packages including Interface Specification, Implementation Guide as well as source code examples for SSP respectively eSSP only!	

## 6.3 ccTalk®

### 6.3.1 General Description

ccTalk® is a serial communications protocol designed by Money Controls to allow 3-wire interfacing between a host and cash handling peripherals. Please contact [support@innovative-technology.com](mailto:support@innovative-technology.com) for further information.

### 6.3.2 Pin Assignments

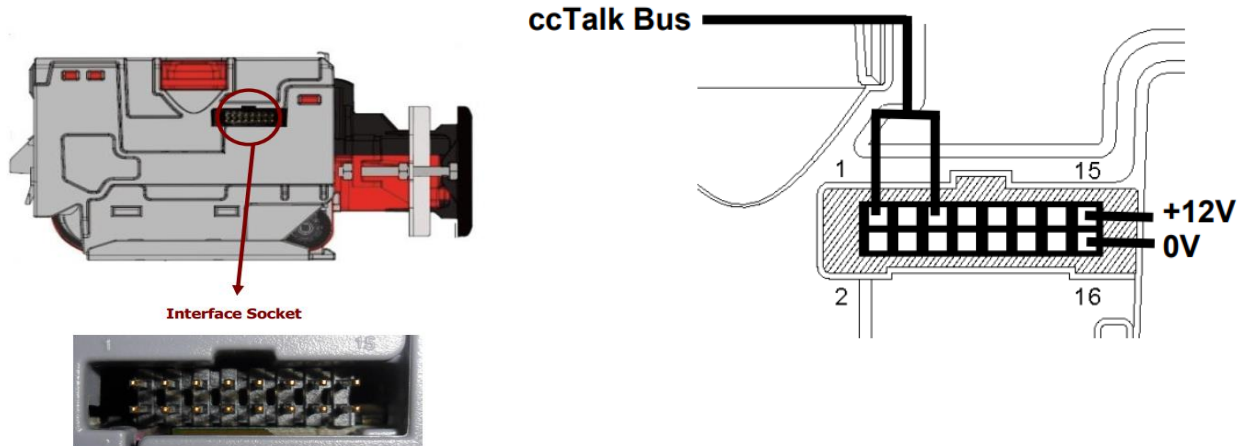

Pin	Name	Type	Description
1	Vend 1	Output	Serial Data (link to Pin 5)
2	Vend 2	Output	DA3 Data Logging
3	Vend 3	Output	Not Used
4	Vend 4	Output	Not Used
5	Inhibit 1	Input	Serial Data (link to Pin 1)
6	Inhibit 2	Input	Not Used
7	Inhibit 3	Input	Not Used
8	Inhibit 4	Input	Not Used
9	Busy	Output	Not Used
10	Escrow	Input	Not Used
11	USB +	Data	USB Data +
12	USB -	Data	USB Data -
13	USB Vcc	Power	USB Vcc (+5VDC)
14	Factory Use Only		Do not connect
15	+ Vin	Power	+12VDC Supply
16	0V	Power	0V Supply (GND)



[<< Back to Contents](#)

## 6.3.3 ccTalk® DES Encryption

When using ccTalk® DES encryption, the NV10USB/+ and host machine must exchange a secret key which forms the basis of the communication encryption. This exchange is performed in a Trusted Mode maintaining security. The Trusted Mode can only be entered by a physical access to the NV10USB/+.

	<b>Caution!</b>
+12VDC and 0V (GND) must always be connected, also when using USB connections.	



[<< Back to Contents](#)

## 6.4 MDB

### 6.4.1 General Description

MDB (Multi-Drop Bus) is used in the vending industry and is now an open standard in the NAMA (National Automatic Merchandising Association) so that all vending and peripheral equipment communicates identically. MDB uses a master-slave model where the VMC (Vending Mechanism Controller) is the master that can communicate with up to 32 slaves (e.g. banknote validator or coin acceptor). Please contact [support@innovative-technology.com](mailto:support@innovative-technology.com) for further information.

Notes:

NV10 USB/+ can only be used in MDB with the addition of an IF5 interface.

The NV10 USB/+ supports the MDB protocol version 1, level 1.

### 6.4.2 Pin Assignments

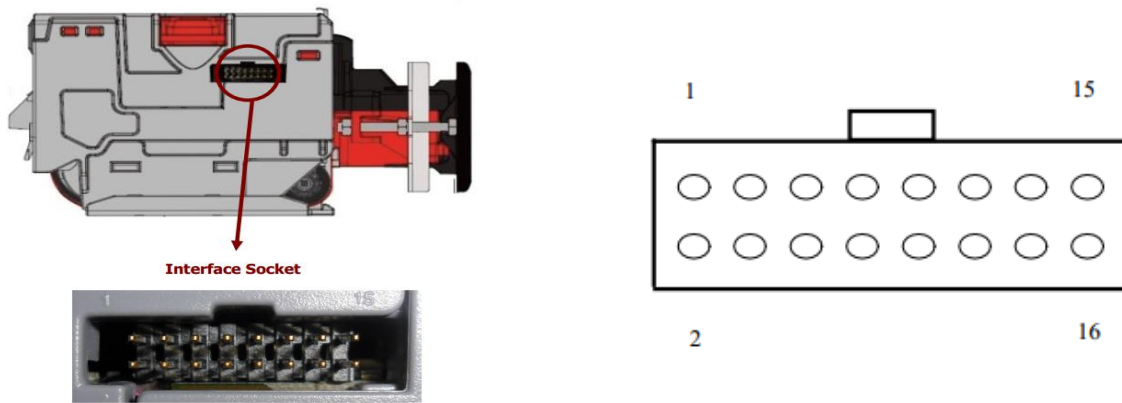

Pin	Name	Type	Description
1	Tx, transmit (ttl levels)	Output	Serial Data
5	Rx, receive (ttl levels)	Input	Serial Data
15	+ Vin	Power	+12/110VDC Supply
16	0V	Power	0V Supply (GND)



[<< Back to Contents](#)

## 6.4.3 IF5 Interface

The IF5 allows the NV10USB/+ to operate with MDB machines no matter the voltage (24/34/48).

A link to the IF5 can be found below.

Webshop Link: <http://innovative-technology.com/shop/accessories/if5-mdb-voltage-converter-detail>



## 6.5 Parallel

### 6.5.1 General Description

Parallel is a 4-way output interface. The first 4 channels have their own individual output which means that only a maximum of 4 channels can be used. If a note is recognised the relevant Vend line is set to low for a period of  $100 \pm 3\text{ms}$ . Pulses outside these limits should be rejected as a precaution against false triggering.

	<b>Caution!</b>
Parallel is an unsecure interface and should not be used for new developments!	

### 6.5.2 Pinout

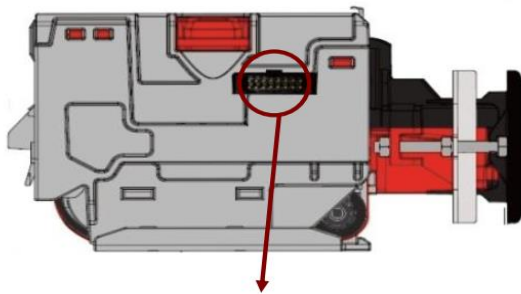

Interface Socket

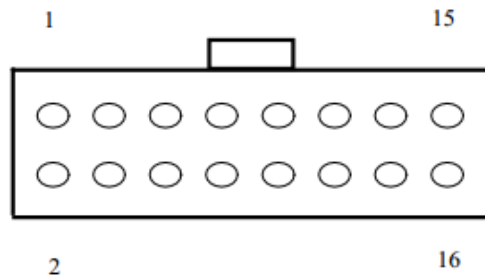

Pin	Name	Type	Description
1	Vend 1	Output	Credit Output Channel 1
2	Vend 2	Output	Credit Output Channel 2
3	Vend 3	Output	Credit Output Channel 3
4	Vend 4	Output	Credit Output Channel 4
5	Inhibit 1	Input	Inhibit Input Channel 1
6	Inhibit 2	Input	Inhibit Input Channel 2
7	Inhibit 3	Input	Inhibit Input Channel 3
8	Inhibit 4	Input	Inhibit Input Channel 4
9	Busy	Output	Busy signal – output is pulled low while the validator is busy
10	Escrow	Input	Input Escrow Control
11	USB +	Data	Not Used
12	USB -	Data	Not Used
13	USB Vcc	Power	Not Used
14	Factory Use Only		Do not connect
15	+ Vin	Power	+12VDC Supply





[<< Back to Contents](#)

16	0V	Power	0V Supply (GND)
----	----	-------	-----------------

### 6.5.3 Inhibit Control

The Inhibits can be used to either enable or disable the acceptance of those banknotes programmed on channels 1, 2, 3 and 4. The Inhibits are internally held high and must be set to low (GND) to enable banknote acceptance. If no Inhibit is set to low (GND) the Master Inhibit is set and the [Product Name] is disabled.

### 6.5.4 Busy Control

This is a general-purpose busy signal. It is active low (Pin 9) while the NV10USB/+ is in operation.

### 6.5.5 Low Power Mode

The Low Power Mode can be used to reduce the power consumption of the NV10USB/+ when idle. When the Low Power Mode option is set, the NV10USB/+ goes into the Low Power Mode after about 6 seconds after the NV10USB/+ is powered up and remains in this state until a note is entered. Following a note insertion, the NV10USB/+ returns to Low Power Mode approximately 1 second after a credit is given or note is rejected. Please, refer to [11.6](#) for details.

### 6.5.6 Escrow Control

The NV10USB/+ has a single note escrow facility. This allows the NV10 USB/+ to hold onto the note once validated, and then only stack the note into a cashbox when the host machine confirms that the Vend operation has been completed. Please refer to [11.5](#) for timing diagram and further details.

### 6.5.7 IF10 Interface

The IF10 is an interface that allows serial SSP to be used in machines without the need of updating the machine software. The IF10 is connected between the NV10 USB/+ and the host machine. The IF10 communicates with the NV10 USB/+ in serial SSP which gives more security along the length of the cable. The IF10 should be mounted close to the host machine control board where the IF10 converts to the parallel connection.



## 6.6 Binary

### 6.6.1 General Description

In the event that the machine needs more than 4 denominations to be recognised but the host machine cannot take advantage of the serial communication method then the NV10 USB/+ can be set to give a binary pattern output on the four parallel output pins. If the NV10 USB+ is set to Binary it will issue the vend signals as a binary pattern on the parallel outputs for  $100 \pm 3$  ms. In this way a maximum of 15 different notes can be accepted and 4 notes individually inhibited.

The four channels have their own individual outputs. If a note is recognised the binary representation of the channel number will be pulled low for  $100 \pm 3$  ms. Pulses outside these limits will be rejected as a precaution against false triggering due to noise.

For example, if a note programmed on channel 3 is credited vend 1 ( $2^0 = 1$  decimal) and vend 2 ( $2^1 = 2$  decimal) will be active low for  $100 \pm 3$  ms.

	<b>Caution!</b>
Binary is an unsecure interface and should not be used for new developments!	



## 6.6.2 Pinout

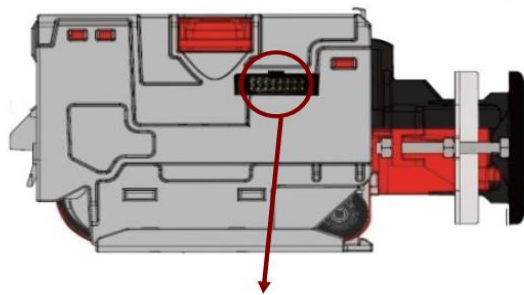

Interface Socket

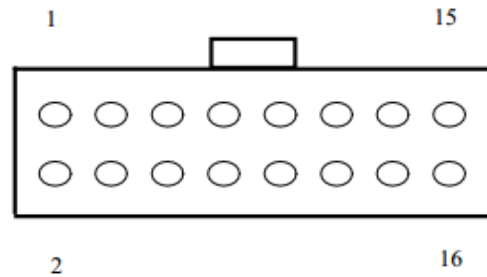

Pin	Name	Type	Description
1	Vend 1	Output	Credit Output binary $2_0 = 1$ decimal
2	Vend 2	Output	Credit Output binary $2_1 = 2$ decimal
3	Vend 3	Output	Credit Output binary $2_2 = 4$ decimal
4	Vend 4	Output	Credit Output binary $2_3 = 8$ decimal
5	Inhibit 1	Input	Inhibit Input Channel 1
6	Inhibit 2	Input	Inhibit Input Channel 2
7	Inhibit 3	Input	Inhibit Input Channel 3
8	Inhibit 4	Input	Inhibit Input Channel 4
9	Busy	Output	Output Busy Signal
10	Escrow	Input	Input Escrow Control
11	USB +	Data	Not Used
12	USB -	Data	Not Used
13	USB Vcc	Power	Not Used
14	Factory Use Only		Do not connect
15	+ Vin	Power	+12VDC Supply
16	0V	Power	0V Supply (GND)

### 6.6.3 Inhibit Control

The Inhibits can be used to either enable or disable the acceptance of those banknotes programmed on channels 1, 2, 3 and 4. The Inhibits are internally held high and must be set to low (GND) to enable banknote acceptance. If no Inhibit is set to low (GND) the Master Inhibit is set and the NV10 USB/+ is disabled.

### 6.6.4 Busy Control

This is a general-purpose busy signal. It is active low (Pin 9) while the NV10USB/+ is in operation.



[<< Back to Contents](#)

## 6.6.5 Low Power Mode

The Low Power Mode can be used to reduce the power consumption of the NV10USB/+ when idle. When the Low Power Mode option is set, the NV10USB/+ goes into the Low Power Mode after about 6 seconds after the NV10USB/+ is powered up and remains in this state until a note is entered. Following a note insertion, the NV10USB/+ returns to Low Power Mode approximately 1 second after a credit is given or note is rejected. Please, refer to [11.6](#) for details.

## 6.6.6 Escrow Control

The NV10USB/+ has a single note escrow facility. This allows the NV10 USB/+ to hold onto the note once validated, and then only stack the note into a cashbox when the host machine confirms that the Vend operation has been completed. Please refer to [11.5](#) for timing diagram and further details.

## 6.6.7 IF9 Interface

The IF9 is an interface that allows serial SSP to be used in machines without the need of updating the machine software. The IF9 is connected between the NV10 USB/+ and the host machine. The IF9 communicates with the NV10 USB/+ in serial SSP which gives more security along the length of the cable. The IF9 should be mounted close to the host machine control board.



[<< Back to Contents](#)

## 6.7 SIO and SI2

### 6.7.1 General Description

SIO (Serial Input/Output) is a very basic and low level serial communication interface. Messages are not echoed back. SIO uses 300 baud whereby SI2 uses 9600 baud.

Please contact [support@innovative-technology.com](mailto:support@innovative-technology.com) for SIO Interface Specification or other details.

	<b>Caution!</b>
<p>SIO and SI2 are outmoded and not recommended for new developments! The NV10USB/+ does not support the simple serial data out only mode. It only supports the serial data input/output mode. The host machine does not echo messages back to the validator. The NV10USB/+ does not operate in true RS232 mode. (Only TTL level). To use Serial Input/Output mode, the SIO interface must be programmed</p>	

There are 4 different combinations of SIO available:

- SIO 300 Baud
- SIO 300 Baud (Disabled at Start up) - A software enable must be sent to enable the validator.
- SIO 9600 Baud
- SIO 9600 Baud (Disabled at Start up) - A software enable must be sent to enable the validator.

The data is formatted as follows:

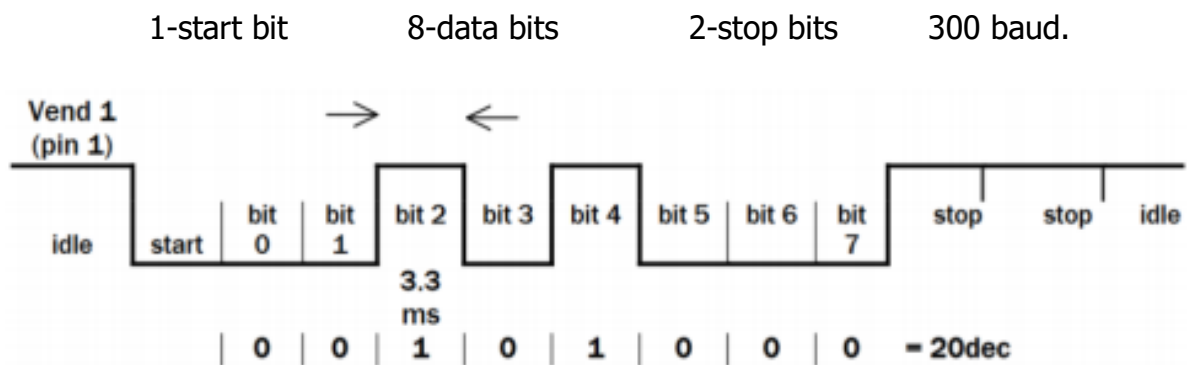

The NV10USB/+ receives/transmits the following Event codes:





# NV10 FAMILY USER MANUAL

[<< Back to Contents](#)

Recognised Receive Codes to BV100		Transmitted codes from BV100	
MESSAGE	DECIMAL VALUE	MESSAGE	DECIMAL VALUE
Inhibit C1	131	Note Accept on C1	1
Inhibit C2	132	Note Accept on C2	2
Inhibit C3	133	Note Accept on C3	3
Inhibit C4	134	Note Accept on C4	4
Inhibit C5	135	Note Accept on C5	5
Inhibit C6	136	Note Accept on C6	6
Inhibit C7	137	Note Accept on C7	7
Inhibit C8	138	Note Accept on C8	8
Inhibit C9	139	Note Accept on C9	9
Inhibit C10	140	Note Accept on C10	10
Inhibit C11	141	Note Accept on C11	11
Inhibit C12	142	Note Accept on C12	12
Inhibit C13	143	Note Accept on C13	13
Inhibit C14	144	Note Accept on C14	14
Inhibit C15	145	Note Accept on C15	15
Inhibit C16	146	Note Accept on C16	16
Un-inhibit C1	151	Note Not Recognised	20
Un-inhibit C2	152	Mechanism running slow	30
Un-inhibit C3	153	Strimming attempted	40
Un-inhibit C4	154	Channel 5 Note Rejected (fraud channel)	50
Un-inhibit C5	155	STACKER Full or Jammed	60
Un-inhibit C6	156	Abort During Escrow	70
Un-inhibit C7	157	Note may have been taken to clear jam	80
Un-inhibit C8	158	Validator Busy	120
Un-inhibit C9	159	Validator Not Busy	121
Un-inhibit C10	160	Command Error	255
Un-inhibit C11	161		
Un-inhibit C12	162		
Un-inhibit C13	163		
Un-inhibit C14	164		
Un-inhibit C15	165		
Un-inhibit C16	166		
Enable serial escrow mode	170		
Disable serial escrow mode	171		
Accept escrow	172		
Reject escrow	173		
Status	182		
Enable all	184		
Disable all	185		
Disable escrow timeout	190		
Enable escrow timeout	191		
Request firmware	192		
Request dataset	193		



# NV10 FAMILY USER MANUAL

[<< Back to Contents](#)

Transaction examples:

Event	Validator	Decimal Value	Host
Note entered into validator	Validator Busy	120→	
Note accepted channel 2	Validator Ready	121→	
	Accept on channel 2	2→	
Note entered into validator	Validator Busy	120→	
Note not recognised	Validator Ready	121→	
	Note not recognised	20→	
Validator has returned note	Validator Ready	121→	
Software Inhibit Channel 4	Inhibit C4	←134	Inhibit C4
	Channel 4 inhibited	134→	
Software Enable Channel 4	Uninhibit C4	←154	Uninhibit C4
	Channel 4 inhibited	154→	
Status Report		←182	Status Request
	Status Requested	182→	
3 byte status message	Inhibit status Channels 1-8	Byte 1→	
	Inhibit status Channels 9-16	Byte 2→	
	Escrow On (=1) / Off (=0)	Byte 3→	
Turn on Escrow Mode		← 170	Enable Escrow Mode
	Escrow Mode Enabled	170→	
Note accept in Escrow Mode			
Note entered into validator	Validator Busy	120→	
Note Accepted Channel 2	Validator Ready	121→	
	Accept on Channel 2	2→	
		←172	Accept Note in Escrow
	Accept Escrow	172→	
	Accept on Channel 2	2→	

## 6.7.2 Pinout

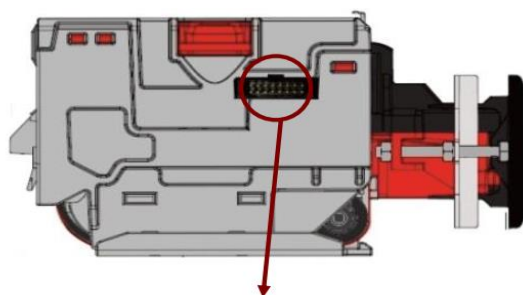

Interface Socket

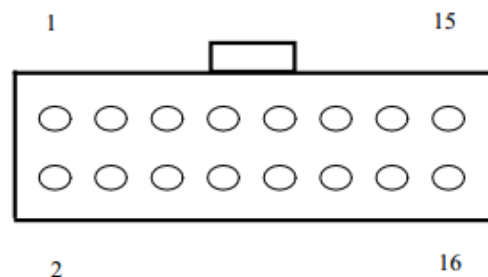

Pin	Name	Type	Description
1	Vend 1	Output	Credit Output Pulse Stream
15	+ Vin	Power	+12VDC Supply
16	0V	Power	0V Supply (GND)





## 6.8 Pulse

### 6.8.1 General Description

Pulse can be used for the acceptance of up to 16 channels. When a note is recognised vend 1 (pin 1) will pulse a pre-set number of times. The amount of pulses as well as the high/low pulse ratio is configurable.

	<b>Caution!</b>
Pulse is an unsecure interface and should not be used for new developments!	

### 6.8.2 Pinout

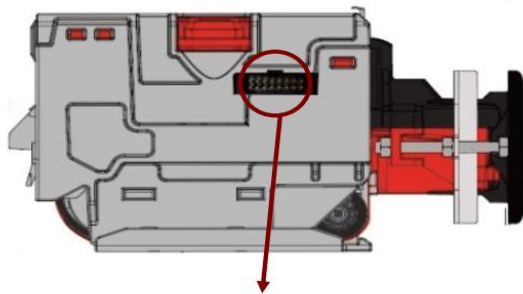

Interface Socket

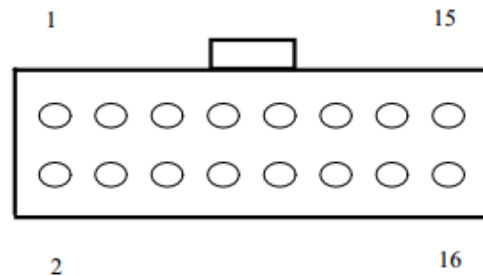

Pin	Name	Type	Description
1	Vend 1	Output	Credit Output Pulse Stream
2	Vend 2	Output	Not Used
3	Vend 3	Output	Not Used
4	Vend 4	Output	Not Used
5	Inhibit 1	Input	Inhibit Input Channel 1
6	Inhibit 2	Input	Inhibit Input Channel 2
7	Inhibit 3	Input	Inhibit Input Channel 3
8	Inhibit 4	Input	Inhibit Input Channel 4
9	Busy	Output	Output Busy Signal
10	Escrow	Input	Input Escrow Control
11	USB +	Data	Not Used
12	USB -	Data	Not Used
13	USB Vcc	Power	Not Used
14	Factory Use Only		Do not connect
15	+ Vin	Power	+12VDC Supply
16	0V	Power	0V Supply (GND)



[<< Back to Contents](#)

## 6.8.3 Inhibit Control

The Inhibits can be used to either enable or disable the acceptance of those banknotes programmed on channels 1, 2, 3 and 4. The Inhibits are internally held high and must be set to low (GND) to enable banknote acceptance. If no Inhibit is set to low (GND) the Master Inhibit is set and the NV10 USB/+ is disabled

## 6.8.4 Busy Control

This is a general-purpose busy signal. It is active low (Pin 9) while the NV10USB/+ is in operation.

## 6.8.5 Low Power Mode

The Low Power Mode can be used to reduce the power consumption of the NV10USB/+ when idle. When the Low Power Mode option is set, the NV10USB/+ goes into the Low Power Mode after about 6 seconds after the NV10USB/+ is powered up and remains in this state until a note is entered. Following a note insertion, the NV10USB/+ returns to Low Power Mode approximately 1 second after a credit is given or note is rejected. Please, refer to [11.6](#) for details.

## 6.8.6 Credit Hold Function

This function is only available if the validator is set to operate in Pulse mode. If the credit hold function is enabled (either by configuration card or BNV Currency Manager Program), the validator will take the note as normal but then wait until the escrow line is toggled low/high. It will then give out the number of pulses per note denomination as set when programmed. After the pulses have been generated, the validator will then wait for another low/high toggle until the full value of credit pulses are given. As an example, with a setting of 4 pulses per banknote, a 5 euro note will give 4 pulses, 5 times. A typical use of this option would be for a pool table with a game price of €1. You could insert a €5 note and press a button that toggles the escrow line and releases the pool balls; this would then allow you to play the first game. The validator holds onto the remaining credits until the game has finished and the button is pressed again allowing the next game to begin, this continues until all the credits have been used. The busy line remains low throughout the whole process and the validator remains inhibited until all pulses are given.

## 6.9 Escrow Control

The NV10 USB/+ has a single note escrow facility (pin 10) used in Parallel, Pulse and Binary modes. This allows the Validator to hold onto the note once accepted, and only stack the note into the cash box when the host machine confirms that the vend operation has been completed. If no confirmation of vend is received then the note will be returned to the customer after 30 seconds. For timing diagrams please refer to section [11.5](#) of this manual.



[<< Back to Contents](#)

## 6.10 IF15 Interface

The IF15 is an interface that allows serial SSP to be used in machines without the need of updating the machine software. The IF15 is connected between the NV10USB/+ and the host machine. The IF15 communicates with the NV10 USB/+ in serial SSP which gives more security along the length of the cable. The IF15 should be mounted close to the host machine control board where the IF15 converts to the pulse connection.



## 7 ROUTINE MAINTENANCE

---

### 7.1 Introduction

The NV10 USB/+ has been designed to minimise any performance variation over time. Much of this is achieved by careful hardware and software design. However, depending upon the environment the NV10 USB/+ may at some time require cleaning, belt changing or note path clearing.

### 7.2 Recommended Cleaning Intervals

Innovative Technology Ltd recommends to clean the optical lenses every month or as required. Dirt, dust or other residue leads to bad note acceptance and other performance degradation. Please refer to [9.3](#) for comprehensive cleaning instructions.

### 7.3 Recommended Belt Changing Intervals

Innovative Technology Ltd recommends to change the drive belts every month or as required. Dirt, dust or other residue leads to bad note acceptance and other performance degradation. Please refer to [9.4](#) for comprehensive belt changing instructions.



## 8 FIRST LEVEL SUPPORT

### 8.1 Bezel/Status LED Flash Codes

The NV10 USB/+ Validator has inbuilt fault detection. If there is a configuration or other error, the NV10 USB/+ front bezel will flash in a particular sequence.

A summary of the Bezel Flash Codes for the NV10 USB/+ is shown below:

Flashes		Indicated Error	Comments
Long	Short		
<b>0</b>	<b>0</b>	None	
<b>1</b>	<b>2</b>	Note path jam	Remove obstruction and follow the cleaning procedure in Section 2 of this manual set
	<b>3</b>	Unit not initialised	Contact ITL technical support
	<b>4</b>	Internal sensor unable to calibrate	Ensure note path is firmly closed, then cycle the power to the unit. If the problem persists contact ITL technical support
<b>3</b>	<b>1</b>	Firmware checksum error	Download new firmware
	<b>2</b>	Interface checksum error or unable to set programmed interface	
	<b>3</b>	EEPROM checksum error	
	<b>4</b>	Dataset checksum error	
<b>4</b>	<b>1</b>	Power supply too low	Check power supply
	<b>2</b>	Power supply too high	



[<< Back to Contents](#)

## 8.2 Checking Power and Communication connections

1. A screened USB 2.0 A-B cable which is less than 5-meters long, should be used in case of direct USB connection, and when TTL-USB adapter is used.
2. Connecting NV10USB/+ via TTL-USB adapters, either IF-17 of DA2 ones should be used. ITL provides principal electrical scheme of IF-17 adapter, please contact [support@innovative-technology.com](mailto:support@innovative-technology.com) for details.
3. Power supply parameters details are described in Section [3.4](#). See also Bezel LED flash codes to identify any validator's errors in section [8.1](#).

## 8.3 Program check procedure

To check settings on a programmed unit:

1. Power the unit.
2. Click the red configuration button present on the side of the unit twice.
3. Monitor the quantity of flashes made by the front bezel and check flash codes below:

	Flash count	Pulse high	Pulse low	Pulse per dollar	High speed	Disabled	ccTalk plain	Low power	Binary	Credit hold
SSP	1									
Pulse	2	ms/10	ms/10	value						3 flash
MDB	3									
IF30	4									
IF31	5									
ccTalk	6						1 flash	2 flash		
SIO	7				1 flash	2 flash				
Parallel spare	8								1 flash	
NIS	10									
IF32	11				1 flash					
spare	12									
spare	13									
spare	14									



## 9 SECOND LEVEL SUPPORT

### 9.1 Introduction

Please use this flow chart with the Flash Codes in subsection [8.1](#) as an aid to help resolve any configuration or startup problems you might have after installing the NV10 USB/+ validator.

### 9.2 Fault Finding Flow Chart

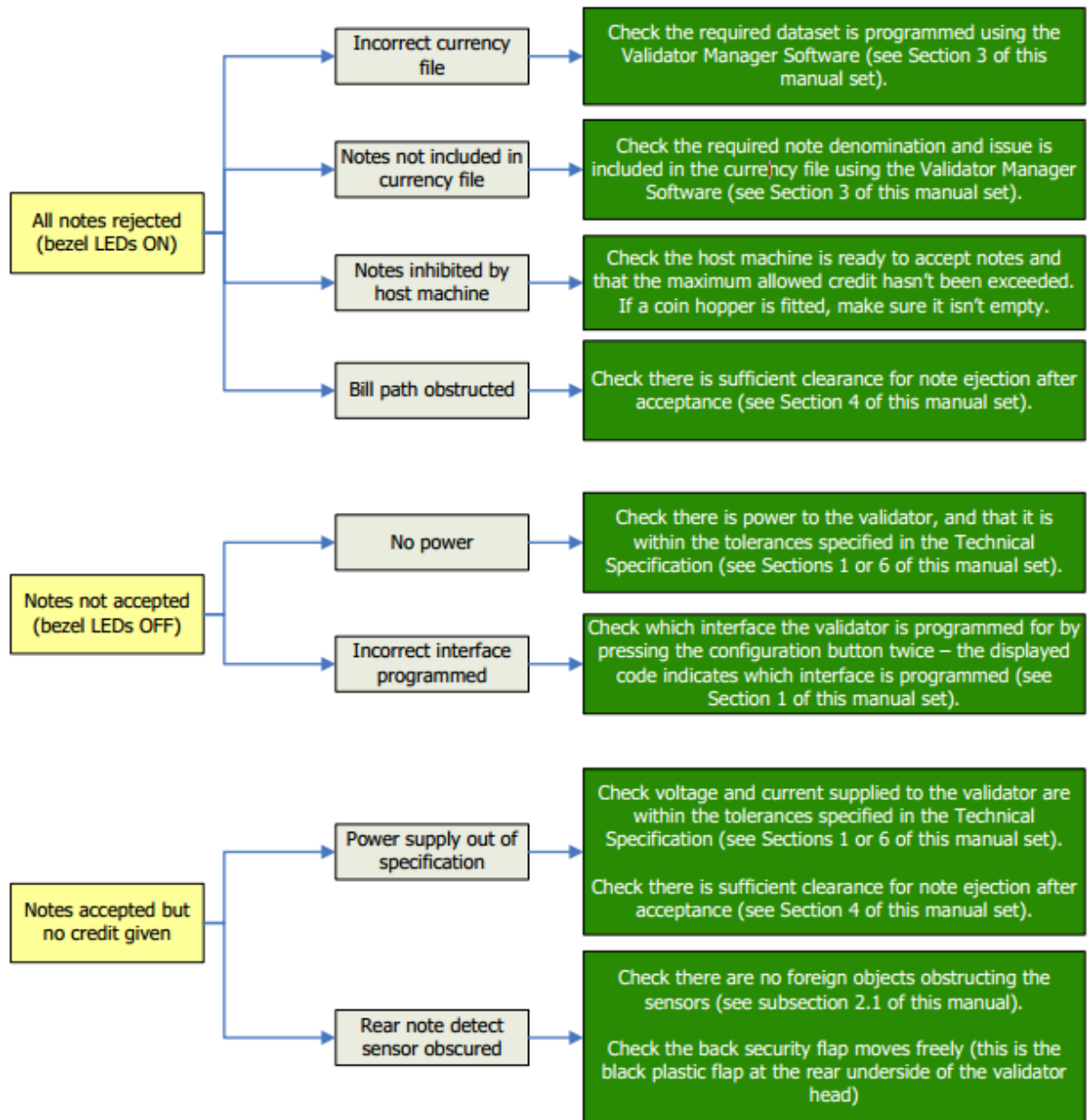

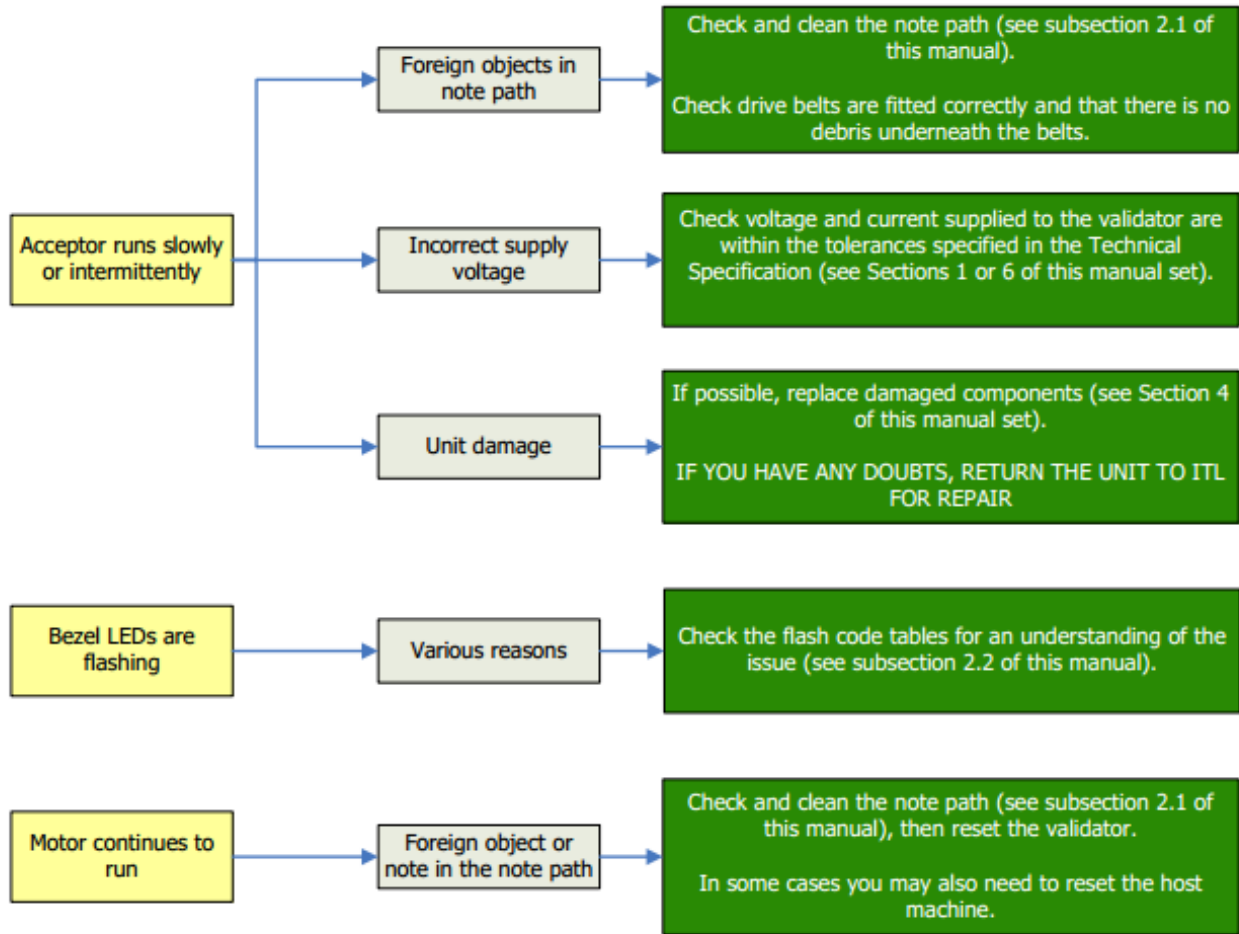



## 9.3 Cleaning the NV10

1. Make sure that the power supply has been removed before performing any repairs to the unit.



2. Remove the bezel by pressing the release button on the top of the unit and rotate the bezel towards the outside.



3. After the bezel has been removed, simultaneously press the two release buttons on the side of the unit and separate the two halves.

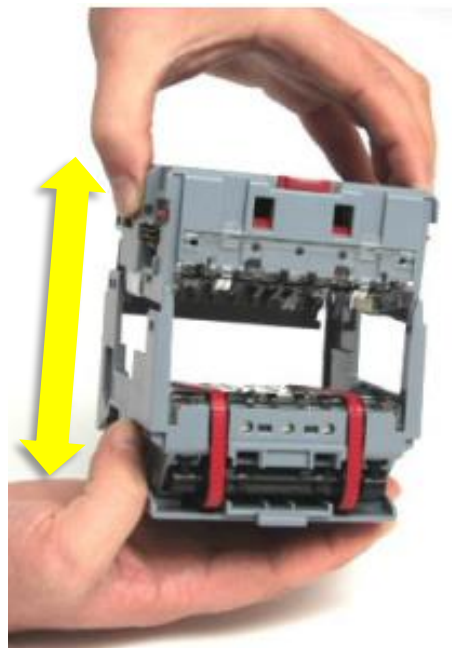

**CAUTION: WHEN CLEANING THE "RECESSED" FRONT SENSOR, USE A SMALL SOFT BRUSH OR COTTON WOOL BUD.**



[<< Back to Contents](#)

- Carefully wipe the surfaces with a soft lint free cloth that has been dampened with a water and mild detergent solution (i.e. household washing up liquid). Take particular care around all the sensor lenses, ensuring they are clean and dry. If a lens has become badly scratched do not attempt to polish it. Contact ITL for further advise, as there may be damage to the optical properties of the lens.

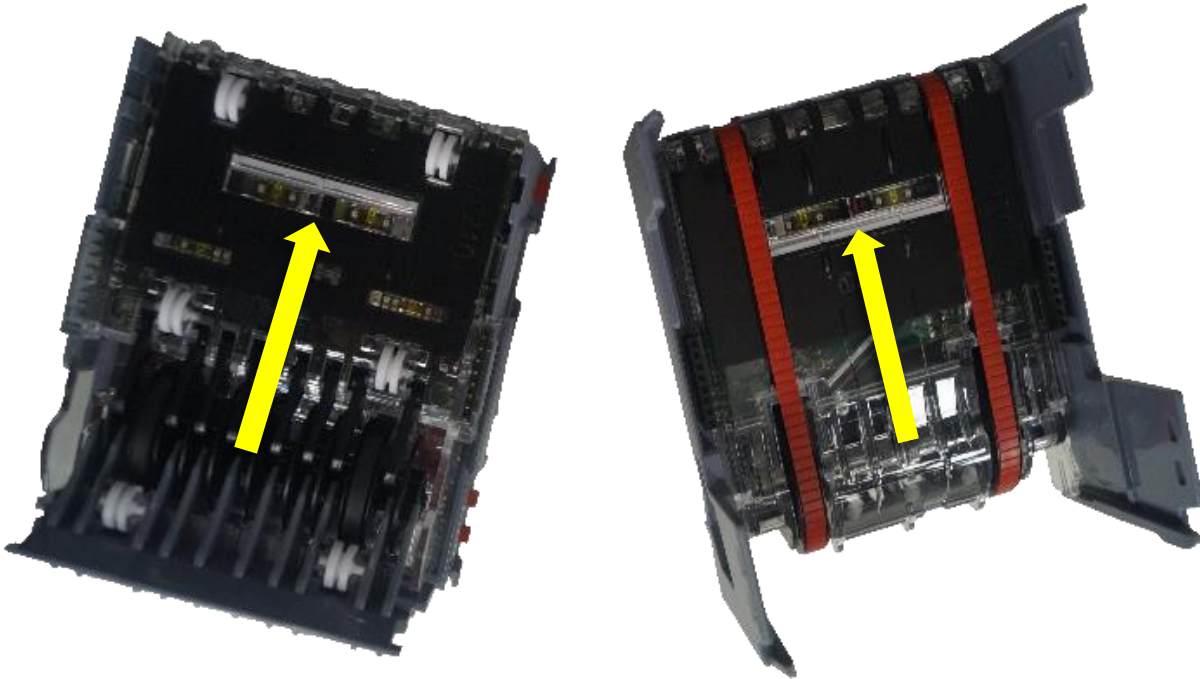

## Caution!

Do not use solvent based cleaners such as alcohol, petrol, methylated spirits, white spirit or PCB cleaner. This will result in permanent damage to the [Product Name], only use a mild detergent.



## Caution!

Dirt, dust or other residue causes bad note acceptance rates and other performance degradation. The recommended cleaning interval is once a month!

[<< Back to Contents](#)

## 9.3.1 Belt cleaning

1. Ensure the validator is enabled (i.e. Bezel lights are illuminated).  
Remove Bezel.
2. Insert a piece of paper, narrower than the width between the two red belts, in the center of the note path to activate the drive motor.
3. Use a lint free cloth dampened with a water and mild detergent solution such as household washing up liquid and hold it against each drive belt as it turns.
4. Repeat steps 3 and 4 until all dust and debris has been removed from both belts.
5. Repeat step 3 using a DRY lint free cloth to remove any excess moisture.

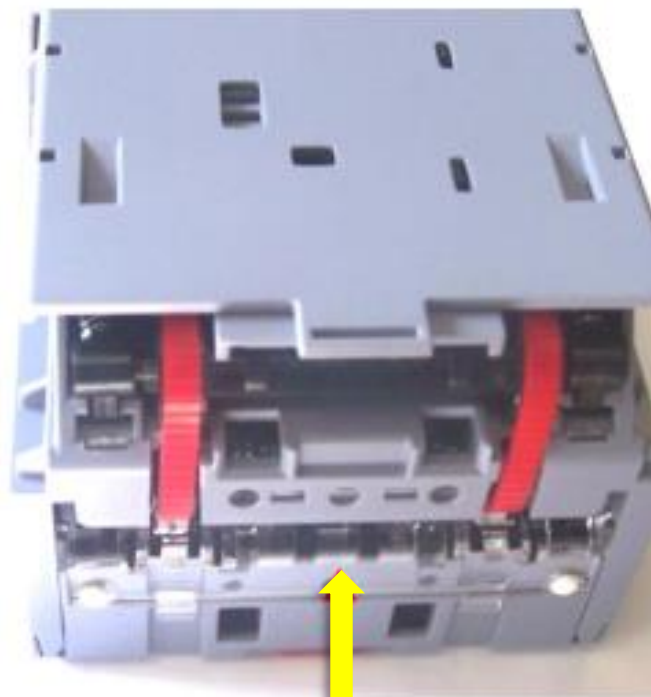

Insert Paper



## 9.4 Changing the Drive Belts

1. Make sure that the power supply has been removed before performing any repairs to the unit.



2. Remove the bezel by pressing the release button on the top of the unit and rotate the bezel towards the outside.



3. After the bezel has been removed, simultaneously press the two release buttons on the side of the unit and separate the two halves.

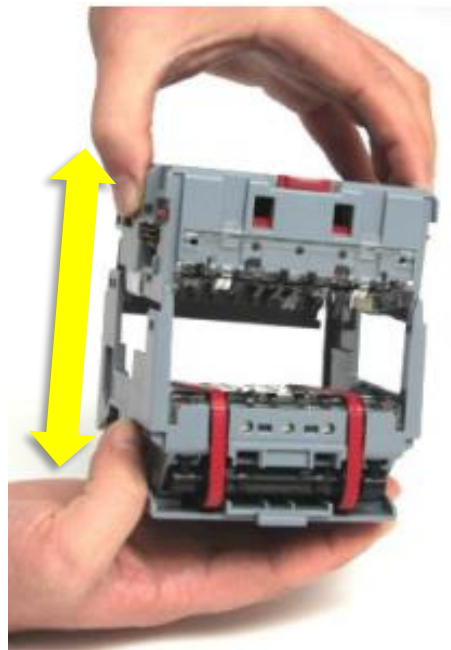

[<< Back to Contents](#)

4. Remove the lower plate by unclipping the front clip while simultaneously pulling forward.

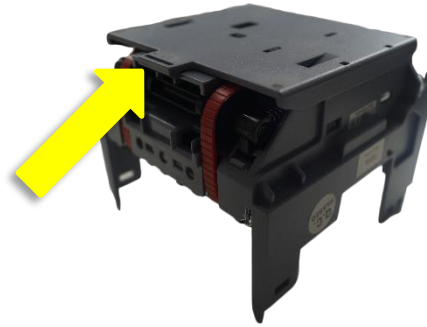

Picture 5 – Description 5

5. Press the plastic bar placed between the belts and pull towards the side one of the drive belts.

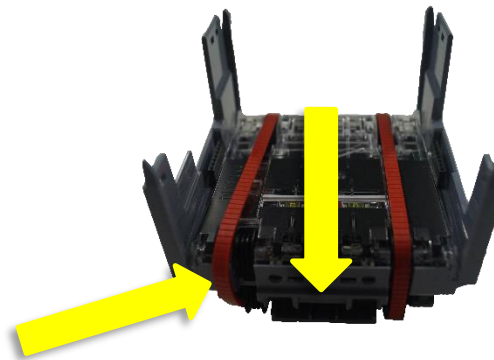

6. Take the drive belt out of both wheels and pass it over the side.

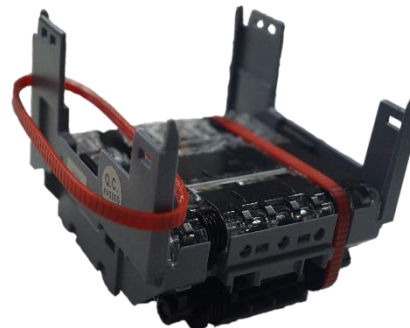

## 9.5 Re-initialisation of the sensors

1. Make sure that the unit is connected and supplied with the correct power supply.



2. Open ITL Diagnostic tools  
And press on the lower left green button "initialise".

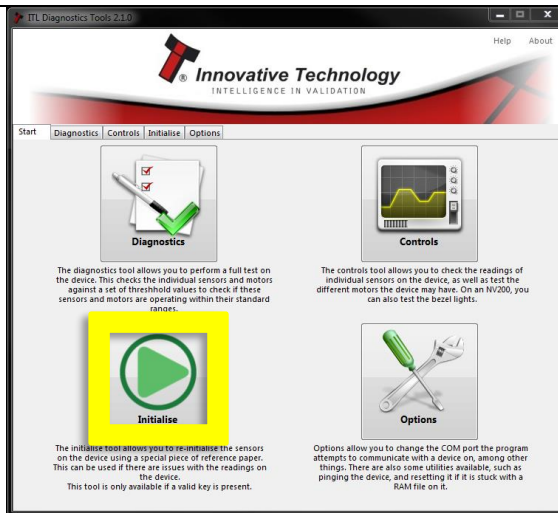

3. Press on the initialise sensor button on the bottom of the screen.

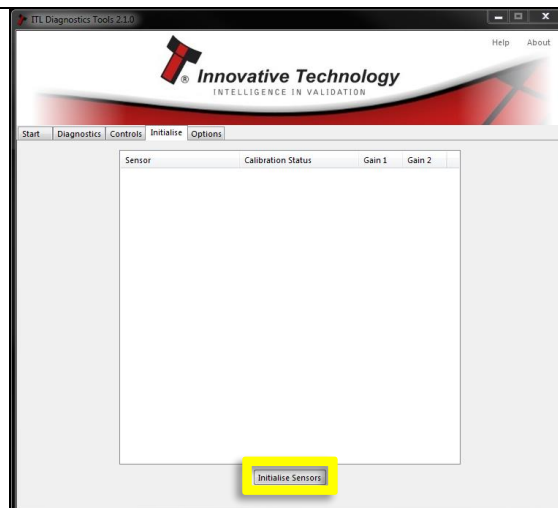



# NV10 FAMILY USER MANUAL

[<< Back to Contents](#)

## 4. Click on "OK"

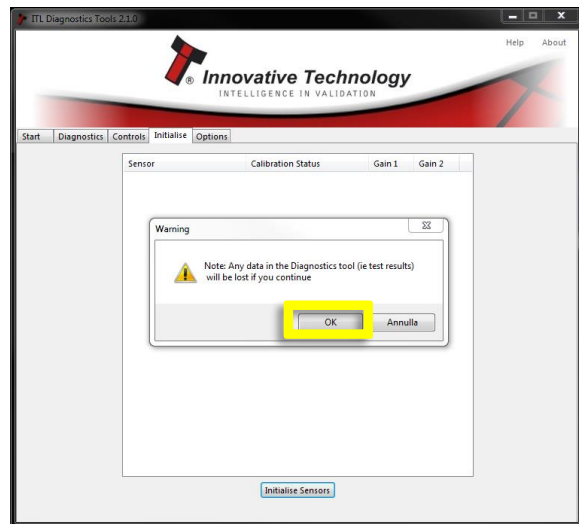

## 5. Wait for the software to gather the unit data.

Picture 5 – Description 5

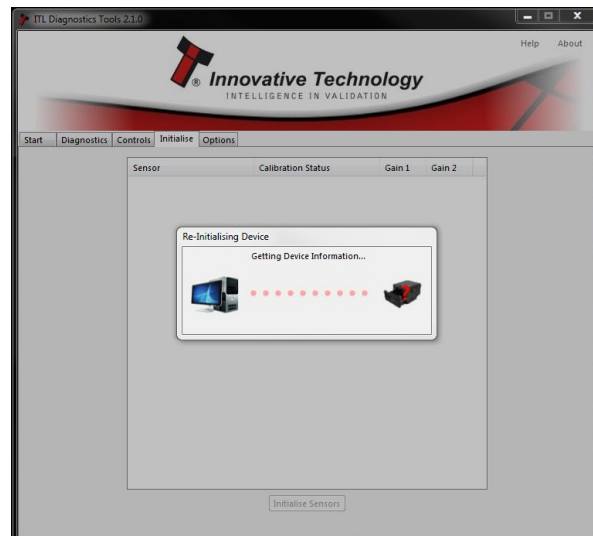

## 6. When motors run continuously, insert Configuration paper.



7. When the initialisation process is complete click on ok to check results.

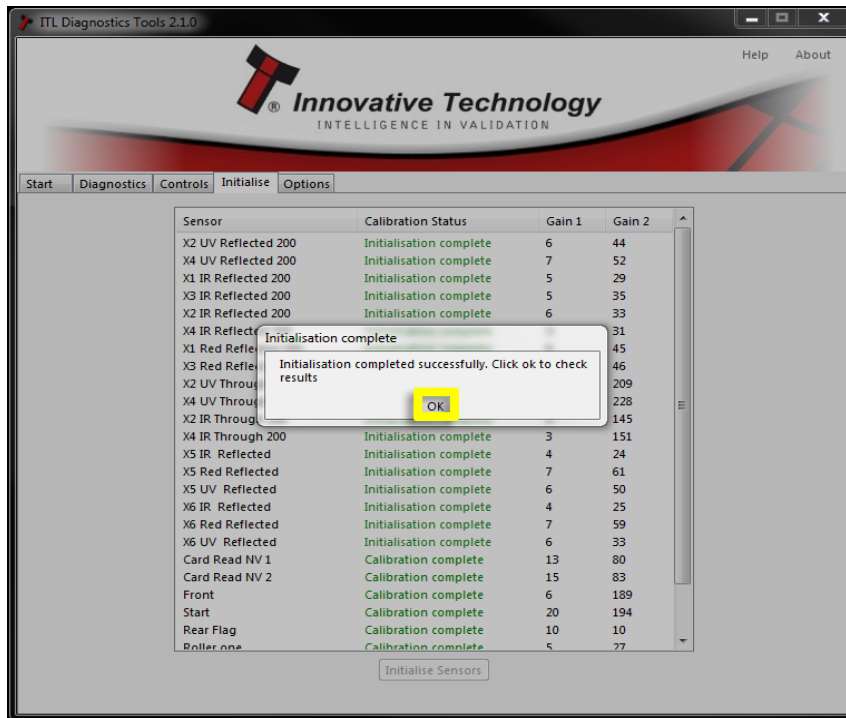



# NV10 FAMILY USER MANUAL

[<< Back to Contents](#)



## 10 COMPLIANCES AND APPROVALS

### 10.1 EC Declaration of Conformity

#### CE Marking

The NV10 USB/+ unit described in this manual set has been designed to comply with the relevant sections of the following Harmonised European Standards:

- EN60950-1:2001
- EN60335-1:2002
- EN60335-2-82:2003

The unit complies with all the applicable essential requirements of the Standards.

#### RoHS

The following products, identified by the part numbers listed in the table below, are compliant with the European Union Directive 2002/95/EC of the Restriction of the use

of certain Hazardous Substances (RoHS) in Electrical and Electronic Equipment.

Product	Description	Lead free date
NV10 USB/+	Bank Note Acceptor Assembly	All NV10 USB/+

We hereby declare that lead (Pb), mercury (Hg), cadmium (Cd), hexavalent chromium (Cr4-6), polybrominated biphenyls (PBB) and polybrominated diphenyl ethers (PBDE), are not intentionally added to our products in amounts exceeding the maximum concentration values as defined by RoHS regulations (except where the application of any of those substances comes within the scope of the RoHS regulations exempted applications).

All compliant products are clearly marked on the product and/or packaging. All the information provided in this statement of compliance is accurate to the best of our knowledge, as of the date of this publication being issued.



[<< Back to Contents](#)

## WEEE

The European Union's directive 2002/96/EC on Waste Electrical and Electronic Equipment (WEEE) was adopted by the European Council and Parliament in 2003 with a view to improving the collection and recycling of Waste Electrical and Electronic Equipment throughout the EU, and to reduce the level of non-recycled waste. The directive was implemented into law by many EU member states during



2005 and 2006. Products and packaging that display the symbol (shown left) indicates that this product must NOT be disposed of with other waste. Instead

it is the user's responsibility to dispose of their Waste Electrical and Electronic Equipment by handing it over to an approved re-processor, or by returning it to the original equipment manufacturer for reprocessing.



# NV10 FAMILY USER MANUAL

[<< Back to Contents](#)

## 11 APPENDIX

### 11.1 Cable Drawings

#### 11.1.1 CN214

DRAWING NO. <b>CN00214</b>		ISSUE <b>A</b>																	
<p><b>Parts List</b></p> <table border="1" style="width: 100%; border-collapse: collapse;"> <thead> <tr> <th>Item</th> <th>QTY</th> <th>Description</th> <th>Vendor</th> </tr> </thead> <tbody> <tr> <td>A</td> <td>1</td> <td>USB Type A Male Connector</td> <td>-</td> </tr> <tr> <td>B</td> <td>1</td> <td>USB Shielded High Speed 2.0 Cable 28AWG/1P+28AWG/2</td> <td>-</td> </tr> <tr> <td>C</td> <td>1</td> <td>USB Type B Male Connector</td> <td>-</td> </tr> </tbody> </table> <p><b>Comments</b></p>				Item	QTY	Description	Vendor	A	1	USB Type A Male Connector	-	B	1	USB Shielded High Speed 2.0 Cable 28AWG/1P+28AWG/2	-	C	1	USB Type B Male Connector	-
Item	QTY	Description	Vendor																
A	1	USB Type A Male Connector	-																
B	1	USB Shielded High Speed 2.0 Cable 28AWG/1P+28AWG/2	-																
C	1	USB Type B Male Connector	-																
<p style="color: red;">Note to Manufacturers</p> <p style="color: red;">Certificates are needed for the following:  <span style="color: red;">■</span> RoHS compliance <span style="color: red;">■</span> UL 94-V0 rated (connector housing) <span style="color: red;">■</span> UL 94-VW1 rated (all other parts)</p>																			
<p style="color: red;">All dimensions are in mm ±5mm, unless specified.</p>																			
<p>APPROVED BY: C. Cardoza</p> <p>DATE: 15/03/2013</p>		<p>DESIGNED BY: C. Cardoza</p> <p>DATE: 15/03/2013</p>																	
<p>APPROVED BY: C. Cardoza</p> <p>DATE: 15/03/2012</p>		<p>DESIGNED BY: C. Cardoza</p> <p>DATE: 15/03/2012</p>																	



# NV10 FAMILY USER MANUAL

[<< Back to Contents](#)

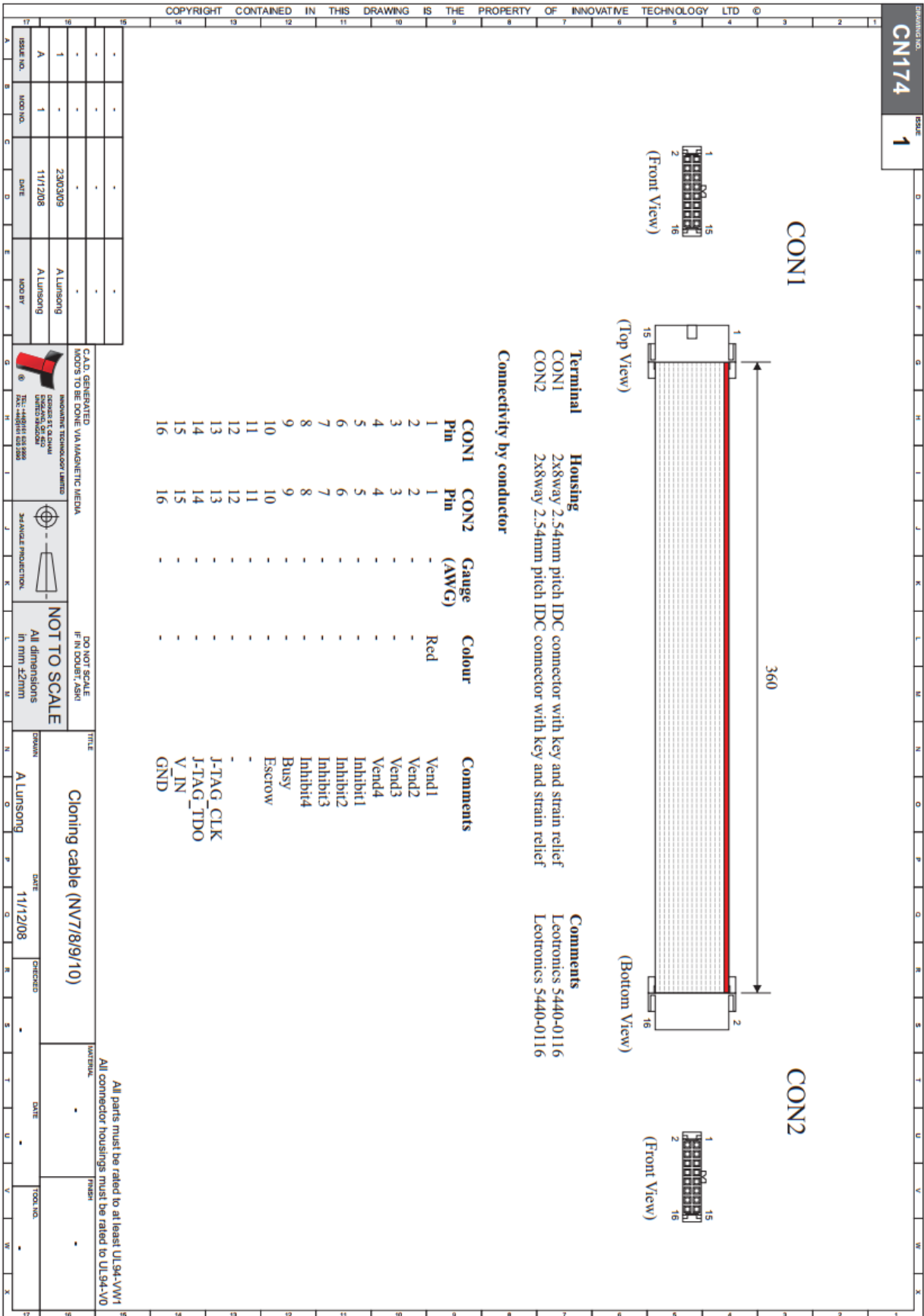

## 11.1.2 CN174



# NV10 FAMILY USER MANUAL

[<< Back to Contents](#)



# NV10 FAMILY USER MANUAL

[<< Back to Contents](#)

## 11.1.3 CN392

CONDUCTOR NO. **CN392**  
 ISSUE **1**

Terminal	Housing	Crimp	Comments
CON1	USB type A plug	-	CON1 connects to host machine
CON2	Molex 90142-0016 (2x8Way 2.54mm pitch with key)	9733272 (tin plated)	CON2 connects to validator

Connectivity by conductor			
CON1	CON2	Gauge	Colour
1	13-	-	Red
2	12	-	White
3	11	-	Green
4	16-	-	Black
-	16	0.2mm <sup>2</sup>	Black
-	15	0.2mm <sup>2</sup>	Red
-	2	-	-
-	3	-	-
-	4	-	-

**Note:** All other pins are unloaded.

**Comments:**  
 V-Bus  
 Data Minus (Twist together with Data Plus)  
 Data Plus (Twist together with Data Minus)  
 USB GND Refer to Figure 1 for connection detail  
 Refer to Figure 1 for connection detail  
 0V, Cable rated to UL1007, Refer to Figure 1 for connection detail  
 +12V, Cable rated to UL1007, Refer to Figure 1 for connection detail  
 Fit unloaded crimp terminal.  
 Fit unloaded crimp terminal.  
 Fit unloaded crimp terminal.  
 Fit unloaded crimp terminal.

**Note:** All parts must be rated to at least UL94-VW1  
 All connector housings must be rated to UL94-V0

ISSUE NO.	MOD NO.	DATE	DESIGNED BY	DATE	CHECKED BY	DATE	FRUIT
1		04/07/10	P Newton	10/07/09			

**Power & USB (type A) Communication Cable**



## 11.2 Switching to Programming Mode (SSP)

Press and hold the configuration button for approximately 2 seconds while the NV10 USB/+ is powered up (until the bezel LED illuminates). The Bezel LED will flash rapidly as the button is released to indicate that SSP is being loaded. Once this process has finished the NV10 USB/+ will reset.

The NV10 USB/+ will now be in Programming Mode (SSP) and allow connection to a PC via a CN392 cable, DA2 adapter or connection to a DA3.

Pressing and holding the button again will return the NV10 USB/+ to its original interface.

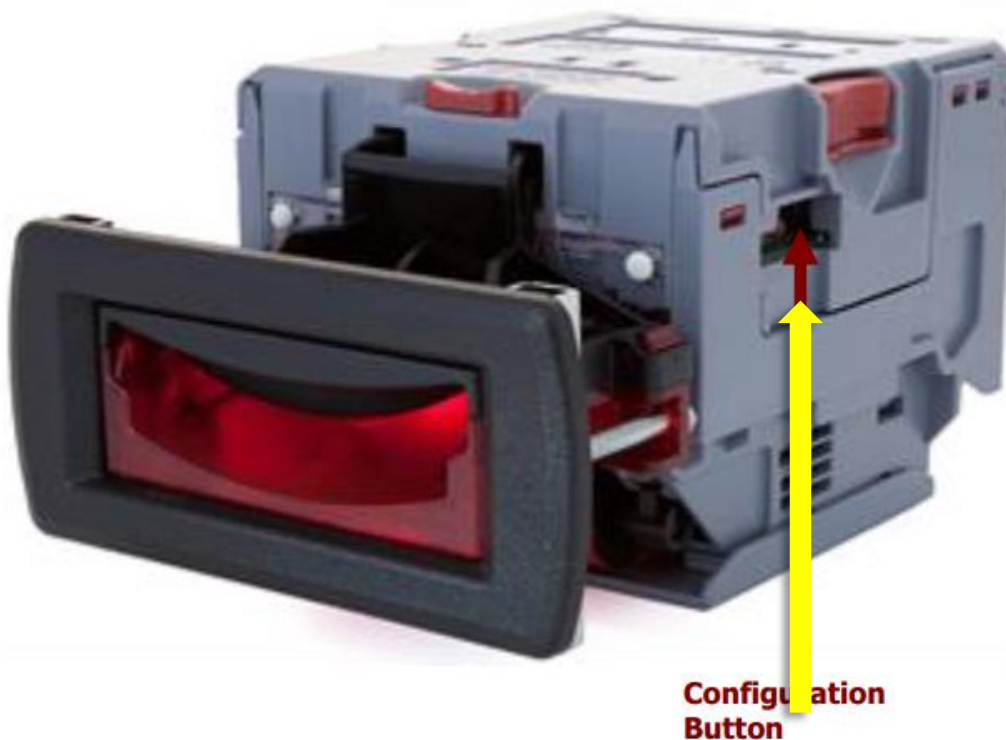



## 11.3 DES Trusted (Safe) Mode

### 11.3.1 Introduction

During the installation of an NV10 USB/+ validator into a host machine, the validator and host must exchange a secret key which forms the basis of the communication encryption. This exchange is performed in a *trusted mode* which can only be accessed by physically pressing the push button on the validator as described below. This ensures that the validator cannot enter trusted mode without having physical access to the validator, maintaining security.

1. Disconnect the cable from the NV10 USB/+ validator.



2. Separate the upper and lower sections of the validator. This is done by pressing in the red clips on the top and pulling away the lower half

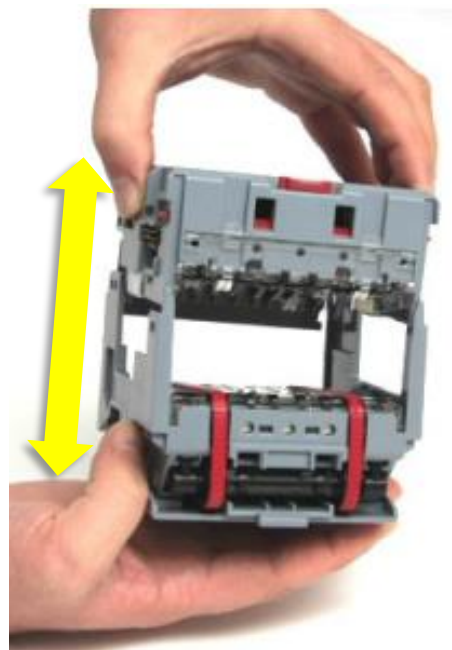

[<< Back to Contents](#)

- 3.** Reconnect the cable to the top half of the NV10 USB/+ validator.

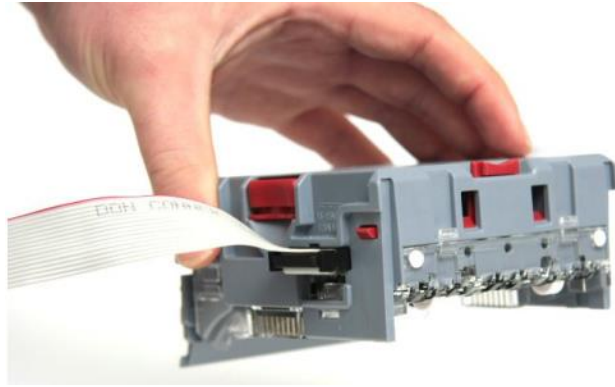

- 4.** Press and hold the push button on the side for over 3 seconds, when the button is released the bezel LED will flash at a constant rate.



- 5.** The NV10 USB/+ is now in trusted mode for 30 seconds. Once the keys are negotiated with the host, disconnect the NV10 USB/+ validator from the cable and re-connect the top and bottom sections. Plug the validator back to the host and your validator should now be installed and configured.



[<< Back to Contents](#)

## **11.4 Escrow Control**

The NV10 USB/+ has a single note escrow facility. This allows the NV10 USB/+ to hold onto the note once validated, and then only stack the note into a cashbox when the host machine confirms that the Vend operation has been completed. If no confirmation of the Vend is received, then the note will be returned to the user after 30 seconds. If the host machine itself aborts the transaction by setting the corresponding inhibit input high, the note is returned immediately. The sequence of



operation is as follows:

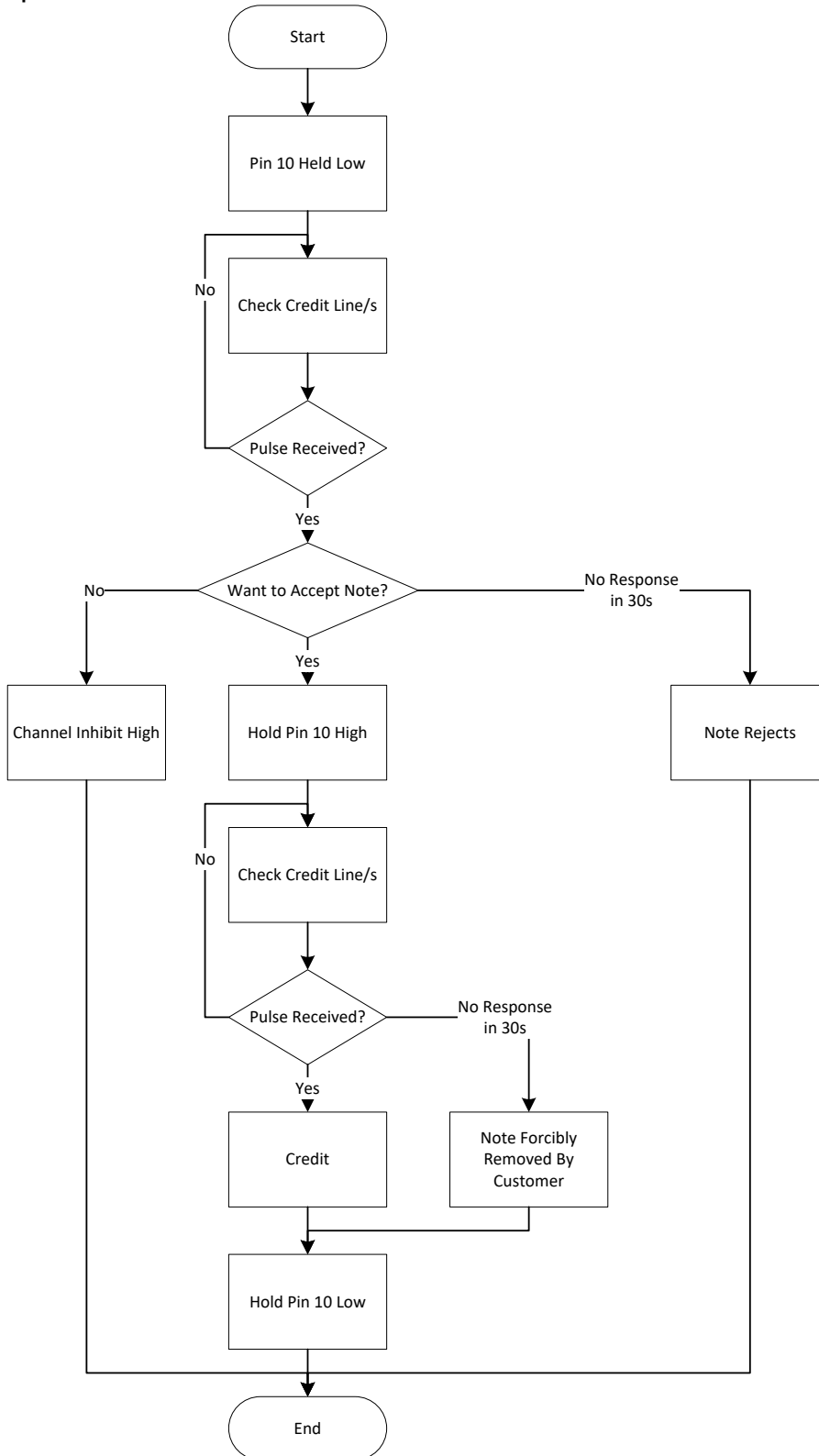

## 11.5 Escrow timing diagram

The NV10 USB/+ has a single note escrow facility (pin 10) used in Parallel, Pulse and Binary modes. This allows the Validator to hold onto the note once accepted, and only stack the note into the cash box when the host machine confirms that the vend operation has been completed.



[<< Back to Contents](#)

If no confirmation of vend is received then the note will be returned to the customer after 30 seconds (see the escrow timing diagrams below):

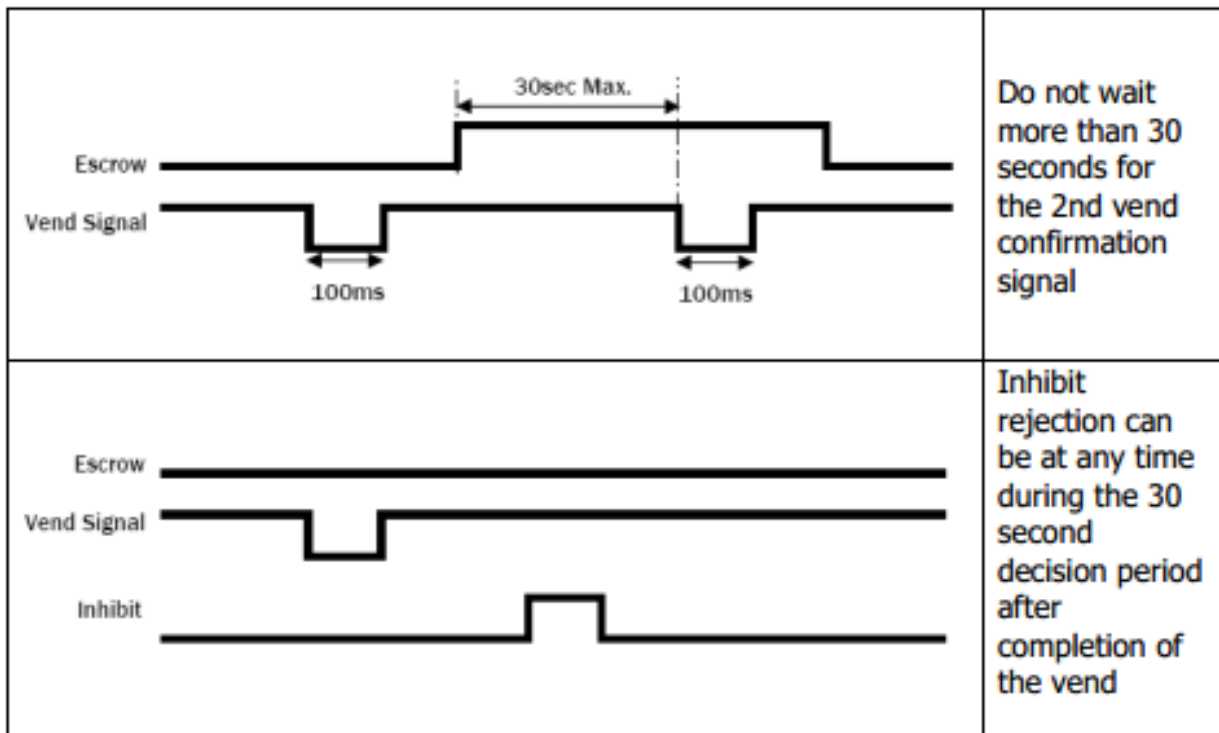

If the host machine itself aborts the transaction by setting the corresponding inhibit input high, the note is returned immediately.

The sequence of operations is as follows:

- Pin 10 is held low awaiting note insertion
- Note inserted. Validator issues a 100 ms pulse on the appropriate channel
- The host machine initiates the vend process
- The host machine sets pin 10 high to indicate that it wants the note. If this is not done within 30 seconds the Validator will return the note
- The Validator issues a 100 ms pulse on the appropriate channel after pin 10 going high to indicate final acceptance of the note. If the signal has not been received within 30 seconds it indicates the customer has forcibly retrieved the note and the vend will be aborted
- The vend process is completed
- The host machine sets pin 10 low ready for the next vend operation

The host machine can force the return of the note to the customer by setting the inhibit line high at any time before the end of the 30 second time-out. For channels above 4 setting all inhibits high will cause a note reject.

In the event of a note being forcibly removed from the mouth of the NV10 USB/+ during the 30 second interval, the NV10 USB/+ will go out of service for 45 seconds.



[<< Back to Contents](#)

## 11.6 Low Power Mode Timing Diagram

Low power Mode can be used with all none serial communication protocols to reduce the power consumption of the NV10USB/+ when idle. When the NV10USB/+ is in this state the current consumption is reduced. The NV10USB/+ goes into low power mode approximately 6 seconds after the validator is powered up and remains in this state until a note is entered (Time A, Figure 10). Following a note insertion, the NV10USB/+ returns to Low Power mode approximately 1 second after the Busy line goes High (After credit is given or note is rejected). (Time B, Figure 10).

Low Power mode uses 3 control lines: Vend - Pin 1, Inhibit - Pin 5 and Busy - Pin 9

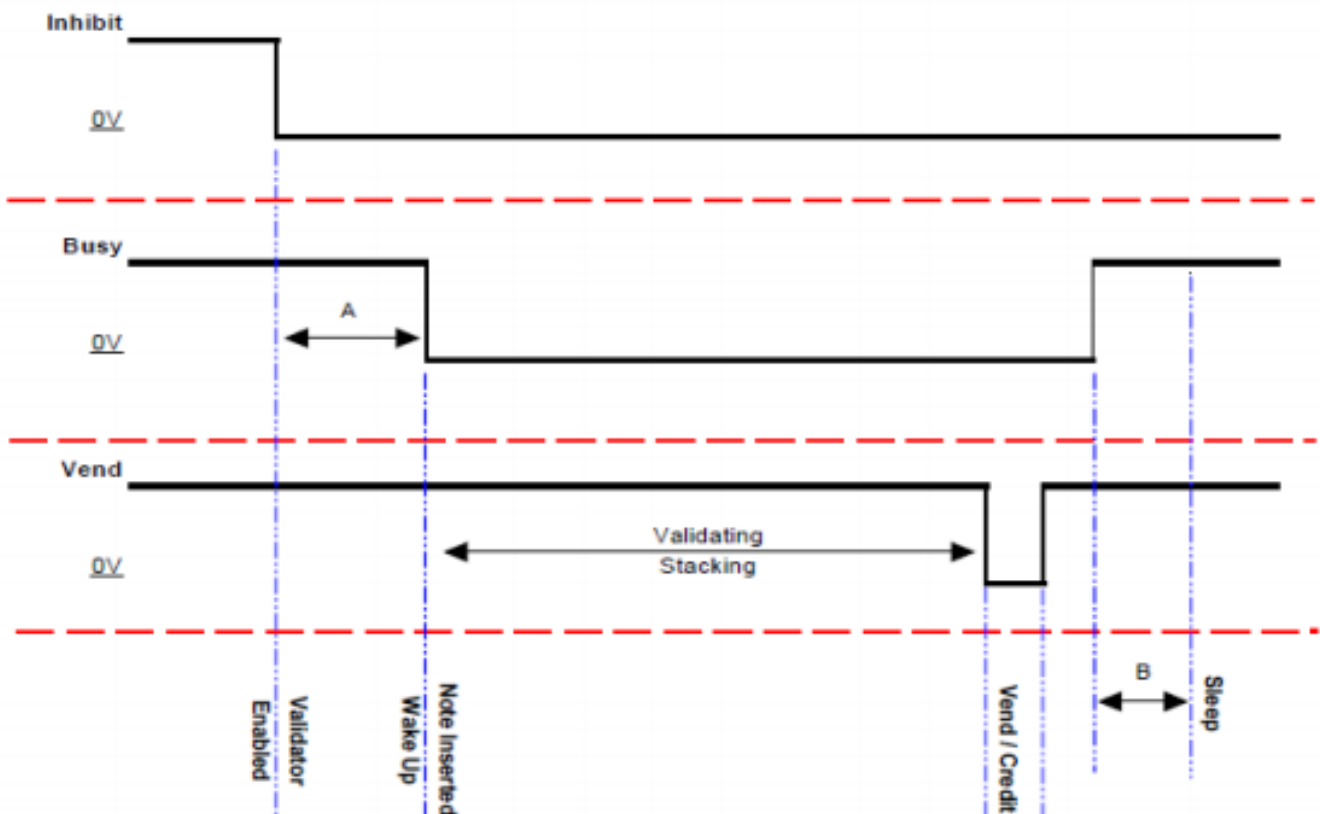

When the Validator is enabled the Inhibit line is Low and the Busy line is High. This remains the same until a note is inserted (Time A). When a note is inserted under the front sensor the NV10USB/+ wakes up and the busy line goes low to indicate that the validator is in use. The busy line remains low during the validating and stacking process and once the note has been successfully validated and stacked the vend line goes low to issue the credit. After the credit is issued the busy line goes high and approximately 1 second after the busy line goes high (Time B) the NV10USB/+ goes back into low power mode.



## 11.7 ST Processor PCN

### 11.7.1 NV10USB+

INNOVATIVE TECHNOLOGY LTD

Product Change Notification

**Product :- NV10USB+**

<b>PCN Issue Date</b>		23/03/2016	
<b>Notification Classification</b>	➤ Mechanical	√	
	➤ Electrical	√	
	➤ Electronic		
	➤ Firmware		
<b>Modification Introduction Date</b>		Spring 2016	
<b>Product Build Revision</b>	-	<b>Document Author</b>	Dan Humble

#### 1.0 Description of Change

Two additional lens sensors have been added to the upper note path of the NV10USB, similar to that of the NV9USB Family.



*Figure 1: Comparison between NV10USB+ vs NV10USB.*



## 1.1 Reason for Change

The extra sensors have been added to help future proof the NV10USB. Having extra sensors to utilise, will allow for further improvements to security, reliability and overall performance moving forward.

## 1.2 Anticipated impact on function, compatibility and reliability.

The NV10USB+ will have identical external dimensions so existing machines that cater for the NV10USB will also be able to fit this new revision. However, this new revision will require a different dataset to that of the original NV10USB (See section 1.3 below for identification info).

## 1.3 Product Identification.

You can identify the different revisions by the following items:

**Label:** The product name should remain the same but with a **BLUE** border.

**Dataset:** The dataset code will have the product ID as H.

NV10USB: GBP01103

NV10USB+: GBP01H03



*Figure 2: Product Identification label.*

**Additional Sensors:** See section 1.0 (Figure 1) for location of new sensors in upper note path.



[<< Back to Contents](#)

## 11.8 File Naming Convention

ITL use a file naming system so dataset/firmware files can be identified and the correct file for the current Validator can be selected, this is especially relevant due to the recent move to the ST processor. Below is an explanation of the file naming convention as well as information on the file names which relate to the NV10 family.

**EUR02144\_NV00103402281000\_IF\_01**

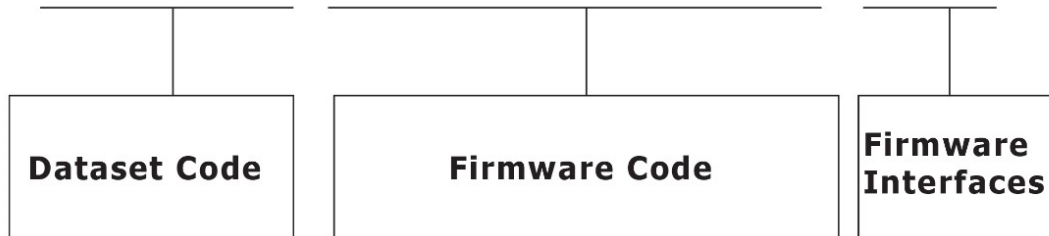

Dataset Code

**EUR 02 1 44**

3 Letter Currency Code	Denomination Code	Validator Type	Version Number
As defined by ISO 4217.	A two-figure number to distinguish between datasets for the same currency that contain different denominations.	1 - NV10USB H - NV10USB+	The version number is incremented each time changes are made to the dataset.

Firmware Code

**NV0010 340 2281000**

Validator Type	Firmware Version	Mod Number
BV0020 - BV20 BV0050 - BV50 BV0100 - BV100 NV0200 - NV200 NV0009 - NV9 NV0010 - NV10USB SH0003 - SH3	3 Digit number incremented with each release of firmware.	Internal ITL modification number.

Firmware Interfaces

**IF\_01**

Firmware Interfaces.
The interfaces included within the firmware file; SSP - Smiley ® Secure Protocol PAR - Parallel PL1 - Pulse CCT - ccTalk MDB - Multi Drop Bus SIO - Serial Input/Output

